

Section 1 - Two Stroke Models

1

Table of Contents





Installation and Maintenance.....	2	Powerhead.....	11
Maintenance Tool Application Chart.....	2	Powerhead Tool Application Chart.....	11
Maintenance Tools.....	2	Powerhead Tools.....	13
Electrical.....	3	Mid-Section.....	17
Electrical Tool Application Chart.....	3	Mid-Section Tool Application Chart.....	17
Electrical Tools.....	4	Mid-Section Tools.....	18
Fuel System.....	8	Lower Unit.....	20
Fuel System Tool Application Chart.....	8	Gear Housing Tool Application Chart.....	20
Fuel System Tools.....	9	Gear Housing Tools.....	23



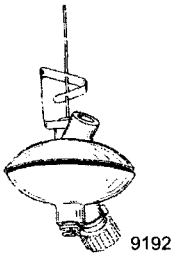

Installation and Maintenance

Maintenance Tool Application Chart

Part No.	Description	2.5/3.3	4/5 102 cc	6-15	20/25 20 Jet	30/40 2 Cyl.	40-60 30/40 Jet	75-125 65/80 Jet	135-200	150-200 EFI	200-250 EFI 3.0L Work
44357Q2	Flushing Device		X		X	X	X	X	X	X	X
888462A1	Data Cable Puller									X	X
17-49930A1	Stainless Steel Tilt Pin							X	X	X	X
91-12612T2	Flushing Device			X							
91-37299Q2	Grease Gun	X	X	X	X	X	X	X	X	X	X
91-66274	Torque Wrench, lb. in.	X	X	X	X	X	X	X	X	X	X
91-90455-1	Lifting Eye					X	X	X	X	X	X
91-98234A2	Transom Drilling Fixture					X	X	X	X	X	X
Snap-On EEP303B	Compression Tester	X	X	X	X	X	X	X	X	X	X
Snap-On EEP309A	Cylinder Leakage Tester	X	X	X	X	X	X	X	X	X	X

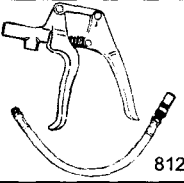
Maintenance Tools

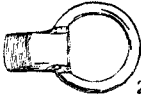
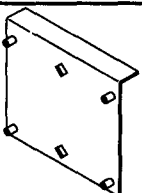
Flushing Device	44357Q 2
	Attaches to the water intakes; provides a fresh water connection when flushing the cooling system or operating the engine.
Data Cable Puller	888462A1
	Attaches to end of DTS data harness to aid in pulling harness through boat. Prevents damage to DTS data harness.
Stainless Steel Tilt Pin	17-49930A 1
	Limits the down trim angle of the power trim equipped engines, or aids in determining the trim out angle on non-power trim engines.
Flushing Device	91-12612T 2
	Attaches to the water intakes; provides a fresh water connection when flushing the cooling system or operating the engine.

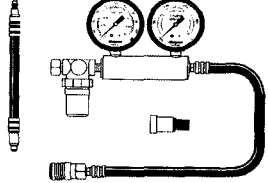
Grease Gun  8120	91-37299Q 2 Aids in the lubrication of key areas on the engine. Allows easy access to grease fittings.
Torque Wrench, lb. in.  10829	91-66274 Dial type torque wrench that sets torque from 9 to 150 lb. in.; 3/8 in. drive.
Lifting Eye  2756	91-90455-1 Threads into the flywheel to remove the powerhead assembly from the driveshaft housing, or to lift entire engine for removal/installation.
Transom Drilling Fixture  5489	91-98234A2 Aids in engine installation by acting as a template for engine mounting holes.
Compression Tester with Adapter  8511	Snap-On EEPV303B Checks cylinder compression. Use with M14 x 1.25 adapter.
Cylinder Leakage Tester  11604	Snap-On EEPV309A Aids in checking cylinder leakdown.

Electrical

Electrical Tool Application Chart



Part No.	Description	2.5/3.3	4/5 102 cc	6-15	20/25 20 Jet	30/40 2-Cyl.	40-60 30/40 Jet	75-125 65/80 Jet	135-200	150-200 EFI	200-250 EFI 3.0L Work
84-822560A5	Adapter Harness								X	X	X
84-822560T12	2 to 4 Pin Harness Adapter								X	X	X

Section 1 - Two Stroke Models

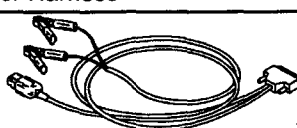

Part No.	Description	2.5/3.3	4/5 102 cc	6-15	20/25 20 Jet	30/40 2-Cyl.	40-60 30/40 Jet	75-125 65/80 Jet	135-200	150-200 EFI	200-250 EFI 3.0L Work
84-825207A2	TPS/CDM Test Harness					X	X	X	X		
91-24161	Protector Cap				X	X	X	X	X	X	X
91-24937A1	Flywheel Holder Strap	X	X	X							
91-52024A1	Remote Starter Switch			X	X	X	X	X	X	X	X
91-52344	Flywheel Holding Tool			X	X	X	X	X	X	X	X
91-58222A1	Dial Indicator		X	X	X	X	X	X	X	X	X
91-63998A1	Spark Gap Tester	X	X	X	X	X	X	X	X	X	X
91-802650-1	Clamp-on Current Probe			X	X	X	X	X	X	X	X
91-818812A1	Ignition Timing Cable					X					
91-83163M	Flywheel Holder	X									
91-83164M	Flywheel Puller/Lifting Ring	X	X	X	X						
91-849154T1	Flywheel Puller					X	X	X	X	X	X
91-850439T1	Spark Gap Tester			X	X	X	X	X	X		
91-853883-1	Timing Decal						X	X	X	X	X
91-853883-3	Timing Decal							X	X	X	X
91-859199	Throttle Position Sensor (TPS) Test Harness									X	
91-881828	Tamper-Proof Screw Torx Bit Set									X	X
91-89045 1	Direct Voltage Adapter		X	X	X	X	X	X	X		
91-892647A01	DMT 2004 Digital Multimeter	X	X	X	X	X	X	X	X	X	X
91-99379	Timing Light		X	X	X	X	X	X	X		
91-99750A1	DVA/Multimeter Kit	X	X	X	X	X	X	X	X	X	X
Order through SPX	Computer Diagnostic System (CDS)									X	X

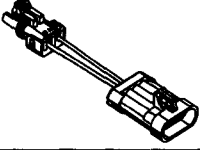
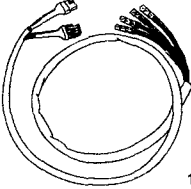
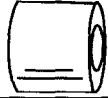
Electrical Tools

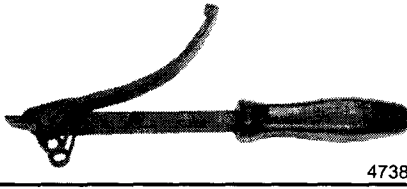
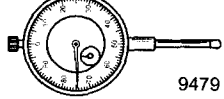
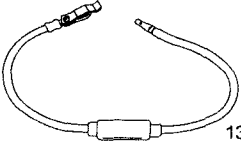
Adapter Harness	84-822560A5
 <p style="text-align: right;">4009</p>	Data link harness between engine and Computer Diagnostic System (CDS) or Digital Diagnostic Terminal (DDT) on engines with a 2 pin diagnostic connection.

2 to 4 Pin Harness Adapter	84-822560T12
 <p>4679</p>	<p>Adapts the 2 pin Digital Diagnostic Terminal harness to the 4 pin connector on the engine.</p>
TPS/CDM Test Harness	84-825207A 2
 <p>13429</p>	<p>Test harness used for capacitor discharge module and throttle position sensor. Aids in testing primary ignition voltage and performing various resistance checks.</p>
Protector Cap	91-24161
 <p>13445</p>	<p>Protects the crankshaft when removing the flywheel; use with flywheel puller (91-849154T 1)</p>
Flywheel Holder Strap	91-24937A 1
 <p>13446</p>	<p>Holds the flywheel on manual start engines when removing the flywheel nut.</p>
Remote Starter Switch	91-52024A1
 <p>10882</p>	<p>Provides a remote starter button to crank the engine when performing service procedures.</p>
Flywheel Holding Tool	91-52344
 <p>4738</p>	<p>Holds and/or turns the flywheel while making engine repairs, also used to torque the flywheel or the engine coupler.</p>
Dial Indicator	91-58222A1
 <p>9479</p>	<p>Used to obtain a variety of measurements including gear backlash, pinion gear location, and TDC.</p>
Spark Gap Tester	91-63998A 1
 <p>13488</p>	<p>Provides a visual indication of spark/coil efficiency.</p>

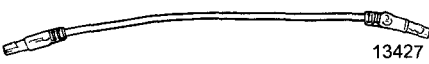
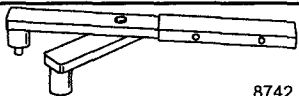
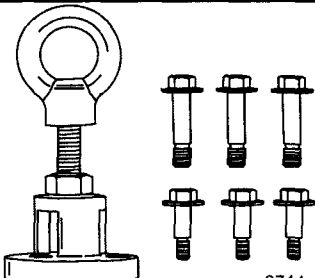
Section 1 - Two Stroke Models

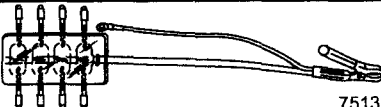
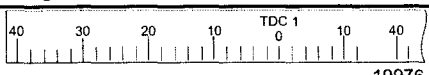
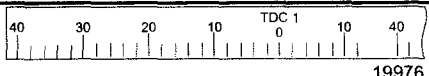
<p>Clamp-on Current Probe</p>  <p>4006</p>	<p>91-802650-1</p> <p>Measures the current output of battery charging systems or current draw of electric motors.</p>
<p>Ignition Timing Cable</p>  <p>13427</p>	<p>91-818812A 1</p> <p>Locks the electronic spark trigger ignition system in base timing mode to set the initial ignition timing; also used as a jumper lead for testing various circuits.</p>
<p>Flywheel Holder</p>  <p>8742</p>	<p>91-83163M</p> <p>Holds and/or turns the flywheel while making engine repairs, also used to torque the flywheel or the engine coupler.</p>
<p>Flywheel Puller/Lifting Ring</p>  <p>8744</p>	<p>91-83164M</p> <p>Removes flywheel from engine. Used for lifting powerhead/engine.</p>
<p>Flywheel Puller</p>  <p>7617</p>	<p>91-849154T 1</p> <p>Removes the flywheel from the crankshaft.</p>
<p>Spark Gap Tester</p>  <p>7513</p>	<p>91-850439T 1</p> <p>Provides a visual indication of spark/coil efficiency.</p>
<p>Timing Decal</p>  <p>19976</p>	<p>91-853883 1</p> <p>Aids in troubleshooting ignition timing on three cylinder engines by determining the timing of individual cylinders.</p>
<p>Timing Decal</p>  <p>19976</p>	<p>91-853883 3</p> <p>Aids in troubleshooting ignition timing on six cylinder engines by determining the timing of individual cylinders.</p>

Section 1 - Two Stroke Models

1

Table of Contents





Installation and Maintenance.....	2	Powerhead.....	11
Maintenance Tool Application Chart.....	2	Powerhead Tool Application Chart.....	11
Maintenance Tools.....	2	Powerhead Tools.....	13
Electrical.....	3	Mid-Section.....	17
Electrical Tool Application Chart.....	3	Mid-Section Tool Application Chart.....	17
Electrical Tools.....	4	Mid-Section Tools.....	18
Fuel System.....	8	Lower Unit.....	20
Fuel System Tool Application Chart.....	8	Gear Housing Tool Application Chart.....	20
Fuel System Tools.....	9	Gear Housing Tools.....	23



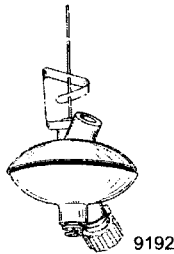

Installation and Maintenance

Maintenance Tool Application Chart

Part No.	Description	2.5/3.3	4/5 102 cc	6-15	20/25 20 Jet	30/40 2 Cyl.	40-60 30/40 Jet	75-125 65/80 Jet	135-200	150-200 EFI	200-250 EFI 3.0L Work
44357Q2	Flushing Device		X		X	X	X	X	X	X	X
888462A1	Data Cable Puller									X	X
17-49930A1	Stainless Steel Tilt Pin							X	X	X	X
91-12612T2	Flushing Device			X							
91-37299Q2	Grease Gun	X	X	X	X	X	X	X	X	X	X
91-66274	Torque Wrench, lb. in.	X	X	X	X	X	X	X	X	X	X
91-90455-1	Lifting Eye					X	X	X	X	X	X
91-98234A2	Transom Drilling Fixture					X	X	X	X	X	X
Snap-On EEP303B	Compression Tester	X	X	X	X	X	X	X	X	X	X
Snap-On EEP309A	Cylinder Leakage Tester	X	X	X	X	X	X	X	X	X	X

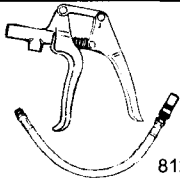
Maintenance Tools

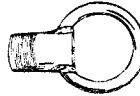
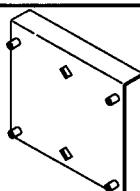
Flushing Device	44357Q 2
 9192	Attaches to the water intakes; provides a fresh water connection when flushing the cooling system or operating the engine.
Data Cable Puller	888462A1
 4618	Attaches to end of DTS data harness to aid in pulling harness through boat. Prevents damage to DTS data harness.
Stainless Steel Tilt Pin	17-49930A 1
 2749	Limits the down trim angle of the power trim equipped engines, or aids in determining the trim out angle on non-power trim engines.
Flushing Device	91-12612T 2
 13497	Attaches to the water intakes; provides a fresh water connection when flushing the cooling system or operating the engine.

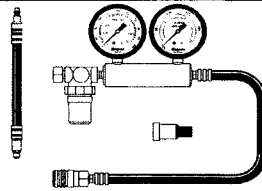
Grease Gun  8120	91-37299Q 2 Aids in the lubrication of key areas on the engine. Allows easy access to grease fittings.
Torque Wrench, lb. in.  10829	91-66274 Dial type torque wrench that sets torque from 9 to 150 lb. in.; 3/8 in. drive.
Lifting Eye  2756	91-90455--1 Threads into the flywheel to remove the powerhead assembly from the driveshaft housing, or to lift entire engine for removal/installation.
Transom Drilling Fixture  5489	91-98234A2 Aids in engine installation by acting as a template for engine mounting holes.
Compression Tester with Adapter  8511	Snap-On EEPV303B Checks cylinder compression. Use with M14 x 1.25 adapter.
Cylinder Leakage Tester  11604	Snap-On EEPV309A Aids in checking cylinder leakdown.

Electrical

Electrical Tool Application Chart





Part No.	Description	2.5/3.3	4/5 102 cc	6-15	20/25 20 Jet	30/40 2-Cyl.	40-60 30/40 Jet	75-125 65/80 Jet	135-200	150-200 EFI	200-250 EFI 3.0L Work
84-822560A5	Adapter Harness								X	X	X
84-822560T12	2 to 4 Pin Harness Adapter								X	X	X

Section 1 - Two Stroke Models

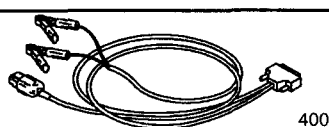

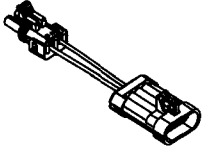
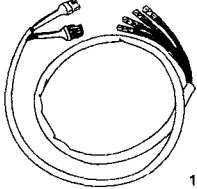
Part No.	Description	2.5/3.3	4/5 102 cc	6-15	20/25 20 Jet	30/40 2-Cyl.	40-60 30/40 Jet	75-125 65/80 Jet	135-200	150-200 EFI	200-250 EFI 3.0L Work
84-825207A2	TPS/CDM Test Harness					X	X	X	X		
91-24161	Protector Cap				X	X	X	X	X	X	X
91-24937A1	Flywheel Holder Strap	X	X	X							
91-52024A1	Remote Starter Switch			X	X	X	X	X	X	X	X
91-52344	Flywheel Holding Tool			X	X	X	X	X	X	X	X
91-58222A1	Dial Indicator		X	X	X	X	X	X	X	X	X
91-63998A1	Spark Gap Tester	X	X	X	X	X	X	X	X	X	X
91-802650-1	Clamp-on Current Probe			X	X	X	X	X	X	X	X
91-818812A1	Ignition Timing Cable					X					
91-83163M	Flywheel Holder	X									
91-83164M	Flywheel Puller/ Lifting Ring	X	X	X	X						
91-849154T1	Flywheel Puller					X	X	X	X	X	X
91-850439T1	Spark Gap Tester			X	X	X	X	X	X		
91-853883-1	Timing Decal						X	X	X	X	X
91-853883-3	Timing Decal							X	X	X	X
91-859199	Throttle Position Sensor (TPS) Test Harness									X	
91-881828	Tamper-Proof Screw Torx Bit Set									X	X
91-89045 1	Direct Voltage Adapter		X	X	X	X	X	X	X		
91-892647A01	DMT 2004 Digital Multimeter	X	X	X	X	X	X	X	X	X	X
91-99379	Timing Light		X	X	X	X	X	X	X		
91-99750A1	DVA/Multimeter Kit	X	X	X	X	X	X	X	X	X	X
Order through SPX	Computer Diagnostic System (CDS)									X	X

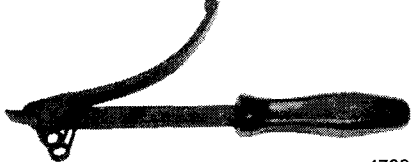
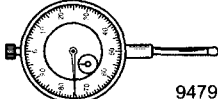
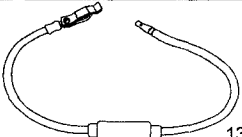

Electrical Tools

Adapter Harness	84-822560A5
 <p style="text-align: center;">4009</p>	Data link harness between engine and Computer Diagnostic System (CDS) or Digital Diagnostic Terminal (DDT) on engines with a 2 pin diagnostic connection.

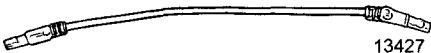
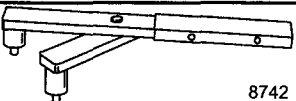
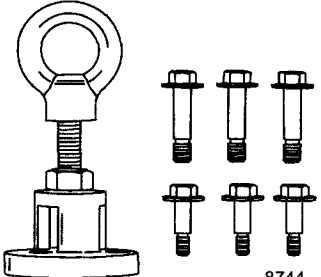
2 to 4 Pin Harness Adapter	84-822560T12
 <p>4679</p>	<p>Adapts the 2 pin Digital Diagnostic Terminal harness to the 4 pin connector on the engine.</p>
TPS/CDM Test Harness	84-825207A 2
 <p>13429</p>	<p>Test harness used for capacitor discharge module and throttle position sensor. Aids in testing primary ignition voltage and performing various resistance checks.</p>
Protector Cap	91-24161
 <p>13445</p>	<p>Protects the crankshaft when removing the flywheel; use with flywheel puller (91-849154T 1)</p>
Flywheel Holder Strap	91-24937A 1
 <p>13446</p>	<p>Holds the flywheel on manual start engines when removing the flywheel nut.</p>
Remote Starter Switch	91-52024A1
 <p>10882</p>	<p>Provides a remote starter button to crank the engine when performing service procedures.</p>
Flywheel Holding Tool	91-52344
 <p>4738</p>	<p>Holds and/or turns the flywheel while making engine repairs, also used to torque the flywheel or the engine coupler.</p>
Dial Indicator	91-58222A1
 <p>9479</p>	<p>Used to obtain a variety of measurements including gear backlash, pinion gear location, and TDC.</p>
Spark Gap Tester	91-63998A 1
 <p>13488</p>	<p>Provides a visual indication of spark/coil efficiency.</p>

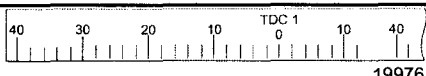
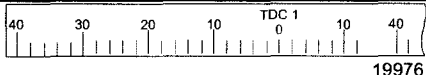
Section 1 - Two Stroke Models

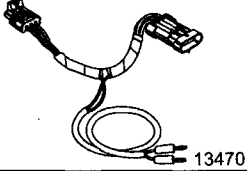
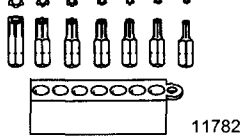
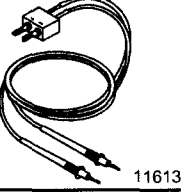
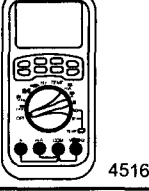
<p>Clamp-on Current Probe</p>  <p>4006</p>	<p>91-802650-1</p> <p>Measures the current output of battery charging systems or current draw of electric motors.</p>
<p>Ignition Timing Cable</p>  <p>13427</p>	<p>91-818812A 1</p> <p>Locks the electronic spark trigger ignition system in base timing mode to set the initial ignition timing; also used as a jumper lead for testing various circuits.</p>
<p>Flywheel Holder</p>  <p>8742</p>	<p>91-83163M</p> <p>Holds and/or turns the flywheel while making engine repairs, also used to torque the flywheel or the engine coupler.</p>
<p>Flywheel Puller/Lifting Ring</p>  <p>8744</p>	<p>91-83164M</p> <p>Removes flywheel from engine. Used for lifting powerhead/engine.</p>
<p>Flywheel Puller</p>  <p>7617</p>	<p>91-849154T 1</p> <p>Removes the flywheel from the crankshaft.</p>
<p>Spark Gap Tester</p>  <p>7513</p>	<p>91-850439T 1</p> <p>Provides a visual indication of spark/coil efficiency.</p>
<p>Timing Decal</p>  <p>19976</p>	<p>91-853883 1</p> <p>Aids in troubleshooting ignition timing on three cylinder engines by determining the timing of individual cylinders.</p>
<p>Timing Decal</p>  <p>19976</p>	<p>91-853883 3</p> <p>Aids in troubleshooting ignition timing on six cylinder engines by determining the timing of individual cylinders.</p>

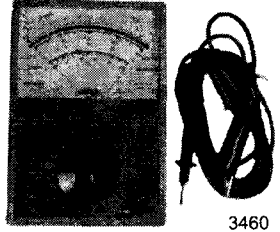
Throttle Position Sensor (TPS) Test Harness	91-859199
	Links between the throttle position sensor and the main engine harness to check the throttle position sensor signal.
Tamper-Proof Screw Torx Bit Set	91-881828
	Aids in the removal of tamper-proof fasteners.
Direct Voltage Adapter	91-89045 1
	Use with a multimeter to check peak voltage on various engine components.
DMT 2004 Digital Multimeter	91-892647A01
	Measures RPM on spark ignition (SI) engines, ohms, amperes, AC and DC voltages; records maximums and minimums simultaneously, and accurately reads in high RFI environments.
Timing Light	91-99379
	Allows a technician to check ignition timing.
DVA/Multimeter Kit	91-99750A 1
	Tests the electrical and ignition systems; consists of a VOA meter with built-in direct voltage adapter.

Section 1 - Two Stroke Models

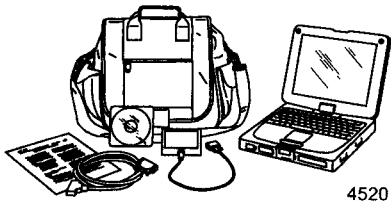
Computer Diagnostic System (CDS)	Order through SPX
	Monitors all electrical systems for proper function, diagnostics, and calibration purposes. For additional information, pricing, or to order the Computer Diagnostic System contact: SPX Corporation 28635 Mound Rd. Warren, MI 48092 or call: USA - 1-800-345-2233 Canada - 800-345-2233 Europe - 49 6182 959 149 Australia - (03) 9544-6222



Fuel System

Fuel System Tool Application Chart



Part No.	Description	2.5/3.3	4/5 102 cc	6/15	20/25 20 Jet	30/40 2-Cyl.	40-60 30/40 Jet	75-125 65/80 Jet	135-200	150-200 EFI	200-250 3.0L Work EFI
22-849606	Schrader Valve Tee									X	X
84-822560A5	Adapter Harness								X	X	X
84-822560T12	2 to 4 Pin Harness Adapter								X	X	X
91-24937A1	Flywheel Holder Strap	X	X	X							
91-52024A1	Remote Starter Switch			X	X	X	X	X	X	X	X
91-804063	Tubing Clamp								X	X	X
91-833169A1	Injector Test Harness									X	
91-850439T1	Spark Gap Tester			X	X	X	X	X	X		
91-859199	Throttle Position Sensor (TPS) Test Harness									X	
91-877870A1	Spark Plug Extension Kit	X	X	X	X	X	X	X	X	X	X
91-881828	Tamper Proof Screw Torx Bit Set									X	X
91-881833A03	Fuel Pressure Gauge Kit							X	X	X	X
91-889236	New Style Vacuumate Carburetor Tuner	X	X	X	X	X	X	X	X		
91-892647A01	DMT 2004 Digital Multimeter	X	X	X	X	X	X	X	X	X	X
91-99379	Timing Light	X	X	X	X	X	X	X	X	X	X

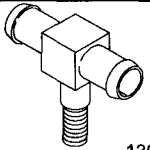
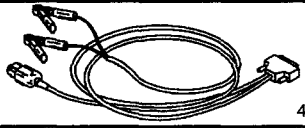
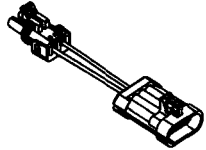

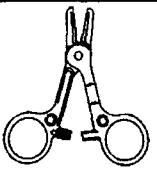
Part No.	Description	2.5/3.3	4/5 102 cc	6/15	20/25 20 Jet	30/40 2-Cyl.	40-60 30/40 Jet	75-125 65/80 Jet	135-200	150-200 EFI	200-250 3.0L Work EFI
91-99750A1	DVA/ Multimeter Kit	X	X	X	X	X	X	X	X	X	X
FT8950	Leakage Tester Kit									X	X
Order through SPX	Computer Diagnostic System (CDS)								X	X	X

Fuel System Tools

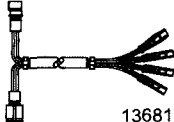
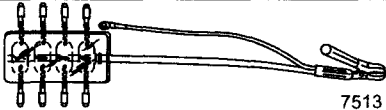
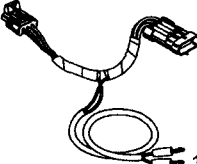
<p>Schrader Valve Tee</p>  <p>13678</p>	<p>22-849606</p> <p>Aids in checking fuel pressure when using a fuel pressure gauge with a screw on schrader valve connector.</p>
<p>Adapter Harness</p>  <p>4009</p>	<p>84-822560A5</p> <p>Data link harness between engine and Computer Diagnostic System (CDS) or Digital Diagnostic Terminal (DDT) on engines with a 2 pin diagnostic connection.</p>
<p>2 to 4 Pin Harness Adapter</p>  <p>4679</p>	<p>84-822560T12</p> <p>Adapts the 2 pin Digital Diagnostic Terminal harness to the 4 pin connector on the engine.</p>
<p>Flywheel Holder Strap</p>  <p>13446</p>	<p>91-24937A 1</p> <p>Holds the flywheel on manual start engines when removing the flywheel nut.</p>
<p>Remote Starter Switch</p>  <p>10882</p>	<p>91-52024A1</p> <p>Provides a remote starter button to crank the engine when performing service procedures.</p>
<p>Tubing Clamp</p>  <p>13688</p>	<p>91-804063</p> <p>Compresses a fuel or vacuum hose for troubleshooting the fuel system or synchronizing a multiple carburetor engine.</p>

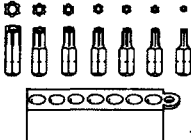
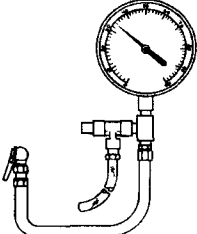
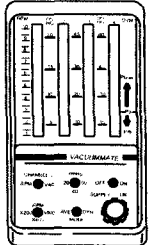
Section 1 - Two Stroke Models

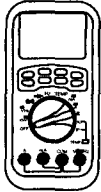
<p>Injector Test Harness</p>  <p>13681</p>	<p>91-833169A 1</p> <p>Connects between the injector harness and the engine harness to verify voltage supplied to injectors, and perform injector resistance tests.</p>
<p>Spark Gap Tester</p>  <p>7513</p>	<p>91-850439T 1</p> <p>Provides a visual indication of spark/coil efficiency.</p>
<p>Throttle Position Sensor (TPS) Test Harness</p>  <p>13470</p>	<p>91-859199</p> <p>Links between the throttle position sensor and the main engine harness to check the throttle position sensor signal.</p>
<p>Spark Plug Extension Kit</p>  <p>20547</p>	<p>91-877870A 1</p> <p>Connects between the spark plug leads and Spark Gap Tester (91-850439T) to provide additional length to the spark plug leads when testing ignition spark.</p>
<p>Tamper-Proof Screw Torx Bit Set</p>  <p>11782</p>	<p>91-881828</p> <p>Aids in the removal of tamper-proof fasteners.</p>
<p>Fuel Pressure Gauge Kit</p>  <p>rms32</p>	<p>91-881833A03</p> <p>Tests the fuel pump pressure; can be used to relieve fuel pressure.</p>
<p>New Style Vacuumate Carburetor Tuner</p>  <p>11630</p>	<p>91-889236</p> <p>Allows the technician to balance the carburetors.</p>

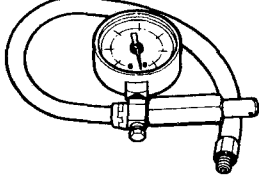
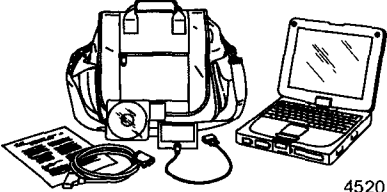
DMT 2004 Digital Multimeter	91-892647A01
 <p>4516</p>	<p>Measures RPM on spark ignition (SI) engines, ohms, amperes, AC and DC voltages; records maximums and minimums simultaneously, and accurately reads in high RFI environments.</p>
Timing Light	91-99379
 <p>11561</p>	<p>Allows a technician to check ignition timing.</p>
DVA/Multimeter Kit	91-99750A 1
 <p>3460</p>	<p>Tests the electrical and ignition systems; consists of a VOA meter with built-in direct voltage adapter.</p>
Leakage Tester Kit	FT8950
 <p>ob01632</p>	<p>Checks gear housing for leakage prior to filling with gear lubricant. Also used to pressurize the oil injection system.</p>
Computer Diagnostic System (CDS)	Order through SPX
 <p>4520</p>	<p>Monitors all electrical systems for proper function, diagnostics, and calibration purposes. For additional information, pricing, or to order the Computer Diagnostic System contact: SPX Corporation 28635 Mound Rd. Warren, MI 48092 or call: USA - 1-800-345-2233 Canada - 800-345-2233 Europe - 49 6182 959 149 Australia - (03) 9544-6222</p>

Powerhead

Powerhead Tool Application Chart



Part No.	Description	2.5/3.3	4/5 102 cc	6-15	20/25 20 Jet	30/40 2-Cyl.	40-60 30/40 Jet	75-125 65/80 Jet	135-200	150-200 EFI	200-250 3.0L Work EFI
91-13662T1	Powerhead Stand			X							
91-13663T1	Piston Pin Tool			X							

Section 1 - Two Stroke Models





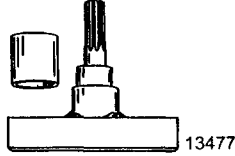
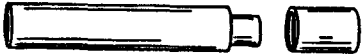
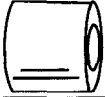
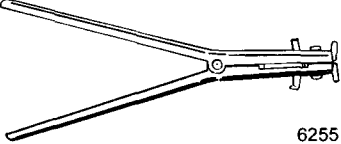

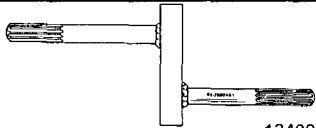
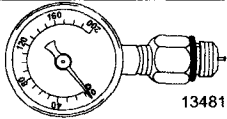
Part No.	Description	2.5/3.3	4/5 102 cc	6-15	20/25 20 Jet	30/40 2-Cyl.	40-60 30/40 Jet	75-125 65/80 Jet	135-200	150-200 EFI	200-250 3.0L Work EFI
91-24161	Protector Cap		X					X	X	X	X
91-24697	Piston Ring Expander	X	X	X	X	X	X	X	X	X	X
91-24937A1	Flywheel Holder Strap	X	X	X							
91-25821T1	Powerhead Stand				X		X				
91-29287	Compression Tester	X	X	X	X	X	X	X	X	X	X
91-30591T1	Powerhead Stand									X	X
91-34569A1	Slide Hammer	X	X	X	X	X	X	X	X	X	X
91-37241	Universal Puller Plate	X	X	X	X	X	X	X	X	X	X
91-52344	Flywheel Holding Tool			X	X	X	X	X	X	X	X
91-52952T1	Lockring Removal Tool					X	X	X	X	X	X
91-58222A1	Dial Indicator	X	X	X	X	X	X	X	X	X	X
91-63209	Torch Lamp	X	X	X	X	X	X	X	X	X	X
91-66274	Torque Wrench lb. in.	X	X	X	X	X	X	X	X	X	X
91-74607A3	Piston Pin Tool					X	X	X	X	X	
91-76160A2	Piston Pin Tool				X						
91-77109A3	Lockring Installation Tool					X	X	X	X	X	
91-79250A2	Water Pressure Gauge			X	X	X	X	X	X	X	X
91-812549T	Powerhead Stand							X	X	X	X
91-818773T	Piston Ring Compressor									X	
91-823237T	Piston Ring Compressor										X
91-827001A1	Powerhead Stand					X	X				
91-83163M	Flywheel Holder	X		X	X						
91-83164M	Flywheel Puller/ Lifting Ring	X		X	X	X					
91-83165T	Bearing Puller Assembly		X								
91-83166M	Bearing Mandrel Kit		X								
91-849154T1	Flywheel Puller					X	X	X	X	X	X
91-892647A01	DMT 2004 Digital Multimeter	X	X	X	X	X	X	X	X	X	X
91-90455-1	Lifting Eye					X	X	X	X	X	X
91-92973A1	Piston Pin Tool										X
91-93004A2	Lockring Installation Tool										X



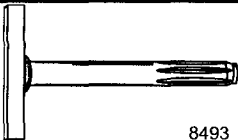

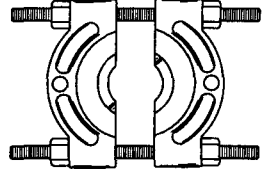
Part No.	Description	2.5/3.3	4/5 102 cc	6-15	20/25 20 Jet	30/40 2-Cyl.	40-60 30/40 Jet	75-125 65/80 Jet	135-200	150-200 EFI	200-250 3.0L Work EFI
Snap-On SRP4	Lock-Ring Pliers							X	X	X	X

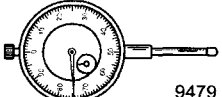
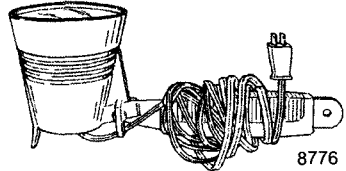
Powerhead Tools



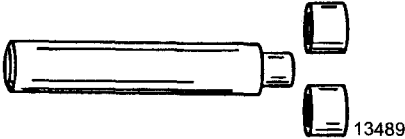
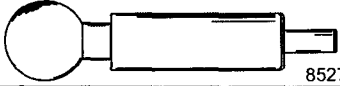
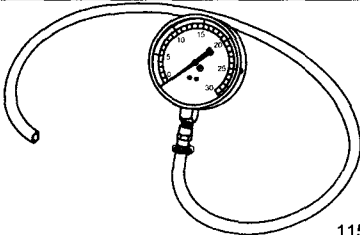

Powerhead Stand	91-13662T 1
 <p>13477</p>	Used to secure and rotate the powerhead during disassembly and assembly.
Piston Pin Tool	91-13663T 1
 <p>11564</p>	Aids in the removal and installation of the piston pins.
Protector Cap	91-24161
 <p>13445</p>	Protects the crankshaft when removing the flywheel; use with flywheel puller (91-849154T 1)
Piston Ring Expander	91-24697
 <p>6255</p>	Expands piston rings for removal and installation.
Flywheel Holder Strap	91-24937A 1
 <p>13446</p>	Holds the flywheel on manual start engines when removing the flywheel nut.
Powerhead Stand	91-25821T 1
 <p>13480</p>	Used to secure and rotate the powerhead during disassembly and assembly.
Compression Tester	91-29287
 <p>13481</p>	Measures engine cylinder compression.

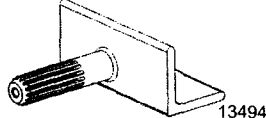
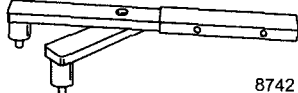

Section 1 - Two Stroke Models

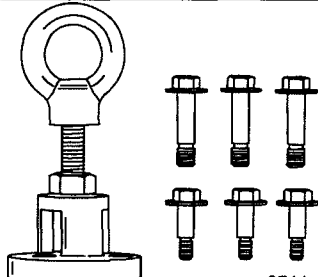
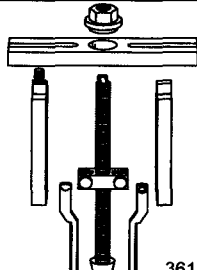
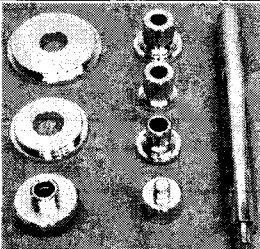
<p>Powerhead Stand</p>  <p>8493</p>	<p>91-30591T 1</p> <p>Used to secure and rotate the powerhead during disassembly and assembly.</p>
<p>Slide Hammer</p>  <p>6761</p>	<p>91-34569A 1</p> <p>Aids in the removal of various engine components. Use with puller jaws.</p>
<p>Universal Puller Plate</p>  <p>8505</p>	<p>91-37241</p> <p>Removes bearings from gears and the driveshaft.</p>
<p>Flywheel Holding Tool</p>  <p>4738</p>	<p>91-52344</p> <p>Holds and/or turns the flywheel while making engine repairs, also used to torque the flywheel or the engine coupler.</p>
<p>Lockring Removal Tool</p>  <p>8500</p>	<p>91-52952T 1</p> <p>Removes the lockrings securing the piston wrist pin.</p>
<p>Dial Indicator</p>  <p>9479</p>	<p>91-58222A1</p> <p>Used to obtain a variety of measurements including gear backlash, pinion gear location, and TDC.</p>
<p>Torch Lamp</p>  <p>8776</p>	<p>91-63209</p> <p>Heats surfaces to aid in the removal and installation of interference fit engine components.</p>
<p>Torque Wrench, lb. in.</p>  <p>10829</p>	<p>91-66274</p> <p>Dial type torque wrench that sets torque from 9 to 150 lb. in.; 3/8 in. drive.</p>
<p>Piston Pin Tool</p>  <p>20637</p>	<p>91-74607A3</p> <p>Aids in the removal and installation of the piston wrist pin.</p>

<p>Piston Pin Tool</p>  <p>13489</p>	<p>91-76160A 2</p> <p>Aids in the removal and installation of the piston pins.</p>
<p>Lockring Installation Tool</p>  <p>8527</p>	<p>91-77109A3</p> <p>Installs the lockrings to secure the piston wrist pin in piston.</p>
<p>Water Pressure Gauge</p>  <p>11598</p>	<p>91-79250A 2</p> <p>Aids in checking the engine water pressure.</p>
<p>Powerhead Stand</p>  <p>8493</p>	<p>91-812549T</p> <p>Used to secure and rotate the powerhead during disassembly and assembly.</p>
<p>Piston Ring Compressor</p>  <p>4739</p>	<p>91-818773T</p> <p>Compresses piston rings into piston ring grooves to ease piston rod assembly into cylinder block.</p>
<p>Piston Ring Compressor</p>  <p>4739</p>	<p>91-823237T</p> <p>Compresses piston rings into piston ring grooves to ease piston rod assembly into cylinder block.</p>
<p>Powerhead Stand</p>  <p>13494</p>	<p>91-827001A 1</p> <p>Used to secure and rotate the powerhead during disassembly and assembly.</p>
<p>Flywheel Holder</p>  <p>8742</p>	<p>91-83163M</p> <p>Holds and/or turns the flywheel while making engine repairs, also used to torque the flywheel or the engine coupler.</p>

Section 1 - Two Stroke Models

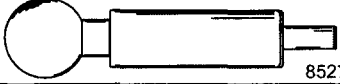
Flywheel Puller/Lifting Ring	91-83164M
 <p>8744</p>	Removes flywheel from engine. Used for lifting powerhead/ engine.
Bearing Puller Assembly	91-83165T
 <p>3610</p>	Removes bearings, races and bearing carriers
Bearing Mandrel Kit	91-83166M
 <p>3421</p>	Aids in the removal and installation of bearings and bearing races.
Flywheel Puller	91-849154T 1
 <p>7617</p>	Removes the flywheel from the crankshaft.
DMT 2004 Digital Multimeter	91-892647A01
 <p>4516</p>	Measures RPM on spark ignition (SI) engines, ohms, amperes, AC and DC voltages; records maximums and minimums simultaneously, and accurately reads in high RFI environments.
Lifting Eye	91-90455--1
 <p>2756</p>	Threads into the flywheel to remove the powerhead assembly from the driveshaft housing, or to lift entire engine for removal/ installation.

Piston Pin Tool  11564	91-92973A 1 Aids in the removal and installation of the piston pins.
Lockring Installation Tool  8527	91-93004A 2 Installs the lockrings to secure the piston wrist pin in piston.
Lock-Ring Pliers  4799	Snap-On SRP-4 Aids in the removal of lock rings.

Mid-Section



Mid-Section Tool Application Chart



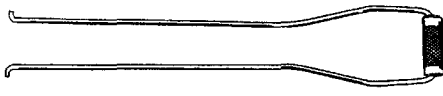

Part No.	Description	2.5/3.3	6-15	30/40 2-Cyl.	40-60 30/40 Jet	75-125 65/80 Jet	135-200	150-200 EFI	200-250 EFI 3.0L Work
91-11230-1	Alignment Tool						X	X	X
91-27780	Puller	X							
91-34569A1	Slide Hammer	X							
91-37241	Universal Puller Plate	X							
91-44486A1	Trim Rod Removal Tool						X	X	X
91-44487T1	Trim Rod Guide Removal Tool						X	X	X
91-52915A6	Power Trim Test Gauge Kit			X	X	X	X	X	X
91-63209	Torch Lamp	X	X	X	X	X	X	X	X
91-74951	Spanner Wrench			X	X	X	X	X	X
91-822778A1	Adapter Fitting			X	X	X			
91-822778A2	Adapter Fitting						X	X	X
91-822778A3	Adapter Fitting			X	X	X	X	X	X
91-875215	Driveshaft Bushing Installation Tool					X			
91-892647A01	DMT 2004 Digital Multimeter		X	X	X	X	X	X	X
91-99750A1	DVA/Multimeter Kit		X	X	X	X	X	X	X
Snap-On CG40-4	Expanding Rod	X							
Snap-On CG41-11	Expanding Rod			X	X	X			
Snap-On CG41-14	Collet			X	X	X			
Snap-On SRP2	Lock-Ring Pliers	X	X	X	X	X	X	X	X

Section 1 - Two Stroke Models

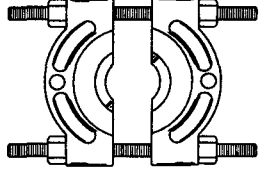
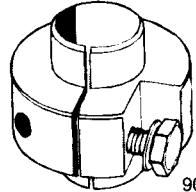
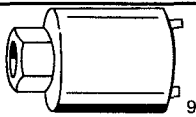
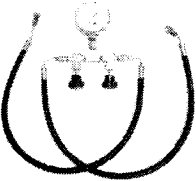

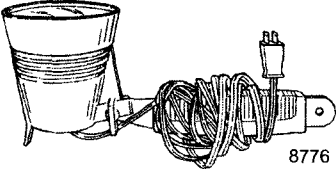
Part No.	Description	2.5/3.3	6-15	30/40 2-Cyl.	40-60 30/40 Jet	75-125 65/80 Jet	135-200	150-200 EFI	200-250 EFI 3.0L Work
Snap-On SRP-4	Lock-Ring Pliers				X	X			X

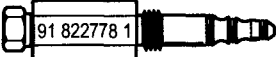
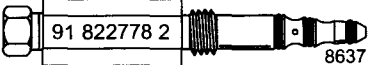
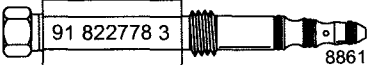
Mid-Section Tools

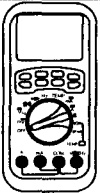
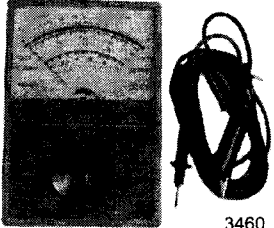
<p>Alignment Tool</p>  <p>9078</p>	91-11230--1	Aligns the tilt ram with housing to aid installation of the pivot pin.
<p>Puller</p>  <p>8760</p>	91-27780	Removes gears, bearings and races.
<p>Slide Hammer</p>  <p>6761</p>	91-34569A 1	Aids in the removal of various engine components. Use with puller jaws.
<p>Universal Puller Plate</p>  <p>8505</p>	91-37241	Removes bearings from gears and the driveshaft.
<p>Trim Rod Removal Tool</p>  <p>9089</p>	91-44486A 1	Aids in the removal of the trim rod from the trim cylinders.
<p>Trim Rod Guide Removal Tool</p>  <p>9086</p>	91-44487T 1	Aids in the removal of the trim rod from the trim cylinders.
<p>Power Trim Test Gauge Kit</p>  <p>3753</p>	91-52915A6	Tests circuit pressures for various trim pumps.

Torch Lamp	91-63209
 <p>8776</p>	Heats surfaces to aid in the removal and installation of interference fit engine components.
Spanner Wrench	91-74951
 <p>8775</p>	Removes and installs trim cylinder end caps.
Adapter Fitting	91-822778A 1
 <p>12203</p>	Measures the internal pressure in the up mode for a single cylinder trim system.
Adapter Fitting	91-822778A 2
 <p>8637</p>	Install in place of the manual release valve to measure the internal pressure of the power trim pump in the up mode.
Adapter Fitting	91-822778A 3
 <p>8861</p>	Install in place of the manual release valve to measure the internal pressure of the power trim pump in the down mode.
Driveshaft Bushing Installation Tool	91-875215
 <p>12202</p>	Aids in the installation of driveshaft bushings.
DMT 2004 Digital Multimeter	91-892647A01
 <p>4516</p>	Measures RPM on spark ignition (SI) engines, ohms, amperes, AC and DC voltages; records maximums and minimums simultaneously, and accurately reads in high RFI environments.
DVA/Multimeter Kit	91-99750A 1
 <p>3460</p>	Tests the electrical and ignition systems; consists of a VOA meter with built-in direct voltage adapter.

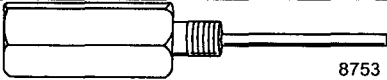
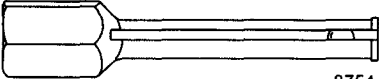
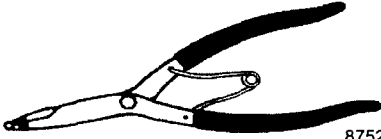
Section 1 - Two Stroke Models

Expanding Rod  12538	Snap-On CG40-4 Aids in the removal of gears and bearings; use with collet.
Expanding Rod  8753	Snap-On CG41-11 Aids in the removal of the spool from the power trim pump.
Collet  8754	Snap-On CG41-14 Aids in the removal of the spool from the power trim pump.
Lock-Ring Pliers  8752	Snap-On SRP2 Removes and installs external snap rings and piston rings.
Lock-Ring Pliers  4799	Snap-On SRP-4 Aids in the removal of lock rings.

Lower Unit

Gear Housing Tool Application Chart

Part No.	Description	2.5/3.3	4/5 102 cc	6-15	20/25 20 Jet	30/40 2 Cyl.	40-60 30/40 Jet	75-125 65/80 Jet	135-200	150-200 EFI	200-250 EFI 3.0L Work
12-34961	Washer				X	X	X				X
12-37429	Load Washer	X									
12-54048	Belleville Washer										X
44-93003	Propeller Shaft Tool								X	X	X
91-12349A05	Pinion Gear Locating Tool						X	X	X	X	X
91-13658T	Mandrel			X							
91-13945	Bearing Installation Driver						X	X			
91-13949	Oil Seal Driver						X	X			
91-14308T02	Bearing Race Driver						X	X			

Section 1 - Two Stroke Models

Part No.	Description	2.5/3.3	4/5 102 cc	6-15	20/25 20 Jet	30/40 2 Cyl.	40-60 30/40 Jet	75-125 65/80 Jet	135-200	150-200 EFI	200-250 EFI 3.0L Work
91-14309T02	Bearing Installation Puller						X	X			
91-14310T1	Wear Sleeve Driver						X	X			
91-14311A04	Bearing Preload Tool						X	X	X	X	X
91-15755T	Needle Bearing Driver						X	X	X	X	X
91-18605A2	Bearing Cup/ Adapter Installation Tool								X	X	X
91-19660-1	Backlash Indicator						X	X			
91-27780	Puller	X	X		X	X	X				
91-31106T	Bearing Cup Driver						X	X	X	X	X
91-31107T	Shift Shaft Bushing Tool								X	X	
91-31108T	Oil Seal Driver						X	X	X	X	X
91-31229A7	Bearing Removal and Installation Kit	X			X	X	X		X	X	X
91-33491	Needle Bearing Driver										X
91-34569A1	Slide Hammer	X		X	X	X	X	X	X	X	X
91-36569T	Driver Head						X	X			X
91-36571T	Pilot Washer				X	X	X		X	X	X
91-37241	Universal Puller Plate	X		X	X	X	X	X	X	X	X
91-37312T	Driveshaft Bearing Driver Head	X				X	X				
91-37323	Driver Rod	X				X	X	X	X	X	X
91-37350T	Pilot Mandrel						X	X			
91-38628T	Puller/Driver Head	X							X	X	X
91-43506T	Driveshaft Bearing Retainer Wrench						X		X	X	X
91-46086A1	Puller Jaws Assembly						X	X	X	X	X
91-53459	Backlash Indicator Rod										X
91-55919	Driver Head					X	X		X	X	
91-56775T	Driveshaft Holding Tool						X	X			X

Section 1 - Two Stroke Models

Part No.	Description	2.5/3.3	4/5 102 cc	6-15	20/25 20 Jet	30/40 2 Cyl.	40-60 30/40 Jet	75-125 65/80 Jet	135-200	150-200 EFI	200-250 EFI 3.0L Work
91-58222A1	Dial Indicator						X	X	X	X	X
91-61067A04	Pinion Nut Wrench										X
91-61069T	Bearing Carrier Retainer Nut Wrench								X	X	X
91-61077T	Propeller Shaft/ Driveshaft Adapter										X
91-66274	Torque Wrench, lb.in.										X
91-74776T	Pinion Height Tool									X	X
91-78473	Backlash Indicator Rod						X	X	X	X	X
91-804776A1	Driveshaft Holding Tool							X			
91-815850	Forward Gear Assembly Tube								X	X	X
91-816242	Puller Jaws										X
91-816243	Guide Plate										X
91-816244	Reverse Gear Needle Bearing Driver										X
91-816245	Needle Bearing Removal Tool										X
91-816292	Needle Bearing Driver										X
91-817005	Forward Gear Bearing Installer						X				
91-817006	Water Pump Base Seal Installer						X				
91-817007T	Bearing Carrier Seal Installer					X	X				
91-817008A2	Pinion Gear Location Tool						X				
91-817009T	Forward Gear Bearing Race Driver Cup						X				
91-817011T	Needle Bearing Installer					X	X				
91-817057A02	Bearing Preload Tool Update Kit						X				
91-817058A1	Lower Driveshaft Bearing Driver Assembly						X				



Section 1 - Two Stroke Models

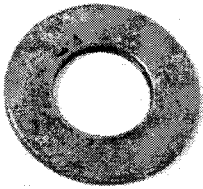

Part No.	Description	2.5/3.3	4/5 102 cc	6-15	20/25 20 Jet	30/40 2 Cyl.	40-60 30/40 Jet	75-125 65/80 Jet	135-200	150-200 EFI	200-250 EFI 3.0L Work
91-817070	Driveshaft Holding Tool						X	X			
91-817569T	Carrier Seal Driver										X
91-821571A1	Water Pump Alignment Pins										X
91-824785T1	Seal/Bushing Installer			X							
91-825200A1	Spring Hook					X	X				
91-826872	Driver					X	X				
91-83155	Dial Indicator Adapter						X	X			X
91-83165T	Bearing Puller Assembly		X	X			X	X			
91-840388	Bearing Carrier Installation Tool										X
91-840393	Bearing Carrier Retainer Nut Wrench										X
91-856875A1	Bearing Driver							X			
91-86642	Cross Pin Tool								X	X	
91-86943T	Guide Plate								X	X	X
91-87120T	Bearing Cup Driver										X
91-877321A1	Bearing Driver							X			X
91-89897	Dial Indicator Holding Tool								X	X	X
91-90094	Driveshaft Holding Tool								X	X	
91-92788T	Pinion Bearing Driver								X	X	X
FT8950	Leakage Tester Kit			X	X	X	X				X
Snap On CG40-4	Expanding Rod	X		X							
Snap On CG41-11	Expanding Rod	X									

Gear Housing Tools

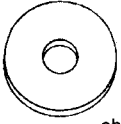
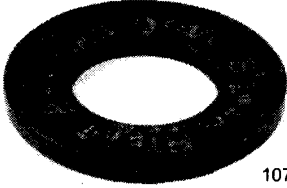
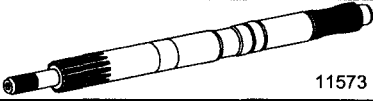
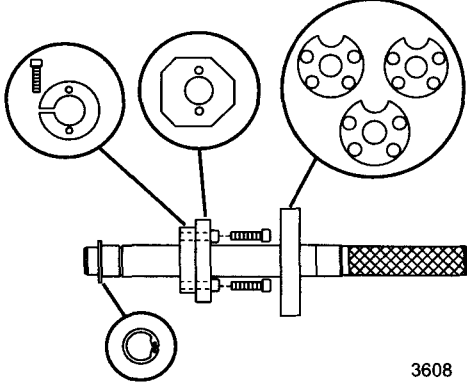

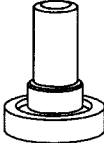
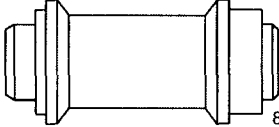
Washer	12-34961
 <p>10834</p>	Use on the threaded puller rod between the nut and plate when removing bearings.

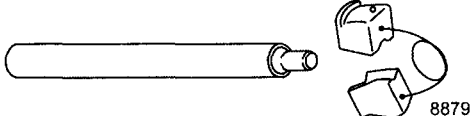

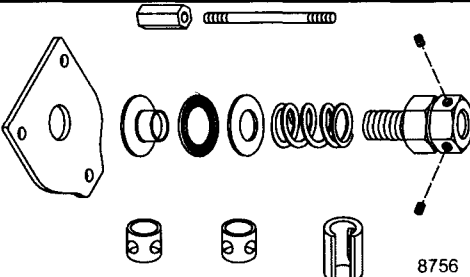
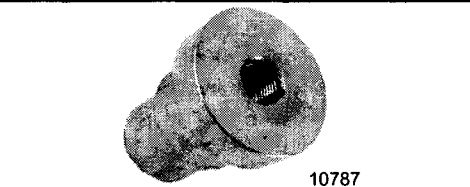
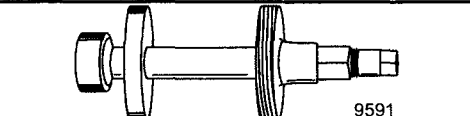
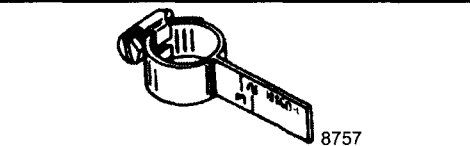
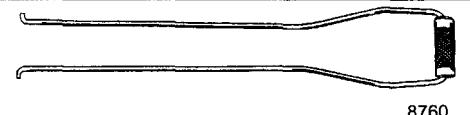

Section 1 - Two Stroke Models

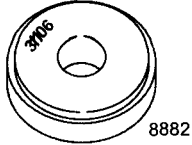
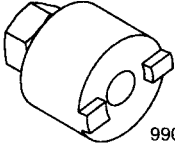
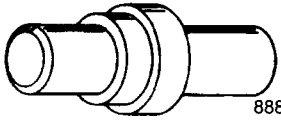
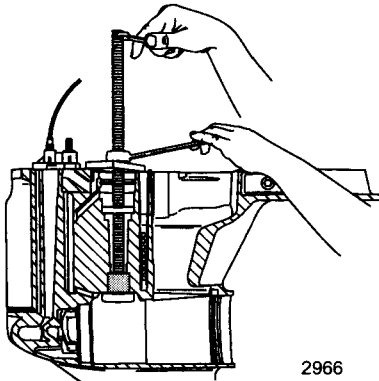
<p>Load Washer</p>  <p>ob01619</p>	<p>12-37429</p> <p>Creates a load on the forward gear when taking forward gear backlash measurements for counter rotation gearcases.</p>
<p>Belleville Washer</p>  <p>10772</p>	<p>12-54048</p> <p>Use with the Pinion Nut Adaptor (91-61067A3) and a propeller nut to check the reverse gear backlash.</p>
<p>Propeller Shaft Tool</p>  <p>11573</p>	<p>44-93003</p> <p>Acts as a dummy propeller shaft when taking forward gear backlash measurements for counter rotation gearcases.</p>
<p>Pinion Gear Locating Tool</p>  <p>3608</p>	<p>91-12349A05</p> <p>Measures pinion gear height.</p>
<p>Mandrel</p>  <p>13513</p>	<p>91-13658T</p> <p>Aids in the installation of bushings, bearings and races into the gearcase.</p>
<p>Bearing Installation Driver</p>  <p>8877</p>	<p>91-13945</p> <p>Installs reverse gear needle bearing into prop shaft carrier.</p>
<p>Oil Seal Driver</p>  <p>8878</p>	<p>91-13949</p> <p>Installs oil seals into water pump base.</p>

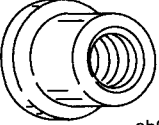
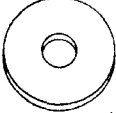
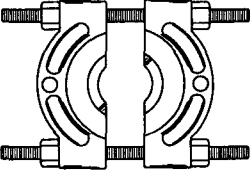
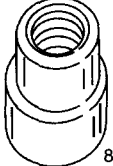

<p>Bearing Race Driver</p>	<p>91-14308T02</p>
 <p>8879</p>	<p>Removes pinion bearing race.</p>
<p>Bearing Installation Puller</p>	<p>91-14309T02</p>
 <p>8880</p>	<p>Installs pinion bearing into gearcase.</p>
<p>Wear Sleeve Driver</p>	<p>91-14310T 1</p>
 <p>8881</p>	<p>Installs wear sleeve onto driveshaft.</p>
<p>Bearing Preload Tool</p>	<p>91-14311A04</p>
 <p>8756</p>	<p>Simulates a load on the driveshaft for accurate pinion height and backlash measurements.</p>
<p>Needle Bearing Driver</p>	<p>91-15755T</p>
 <p>10787</p>	<p>Installs needle bearings into bearing carriers.</p>
<p>Bearing Cup/Adapter Installation Tool</p>	<p>91-18605A 2</p>
 <p>9591</p>	<p>Installs the forward gear bearing race on a standard gearcase. Presses the reverse gear bearing adapter into the gear housing on a counter rotating gearcase.</p>
<p>Backlash Indicator</p>	<p>91-19660--1</p>
 <p>8757</p>	<p>Measures gear backlash.</p>
<p>Puller</p>	<p>91-27780</p>
 <p>8760</p>	<p>Removes gears, bearings and races.</p>

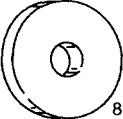
Section 1 - Two Stroke Models

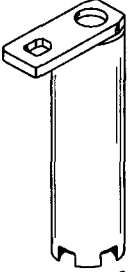

<p>Bearing Cup Driver</p>  <p>8882</p>	<p>91-31106T</p> <p>Installs the driven gear bearing cup.</p>
<p>Shift Shaft Bushing Tool</p>  <p>9906</p>	<p>91-31107T</p> <p>Aids in the removal and installation of the shift shaft bushing.</p>
<p>Oil Seal Driver</p>  <p>8883</p>	<p>91-31108T</p> <p>Installs bearing carrier oil seals.</p>
<p>Bearing Removal and Installation Kit</p>  <p>2966</p>	<p>91-31229A7</p> <p>Installs and removes the bearings in all gearcases. 91-31229A7 tool assembly includes the following components: 11-24156 Hex Nut 12-34961 Washer 91-15755T Bearing Carrier 91-29310 Plate 91-29610 Pilot Plate 91-30366T1 Mandrel 91-31229 Puller Shaft 91-32325T Driver Head 91-32336 Driver Needle Bearing 91-36379 Puller/Head Gear 91-36569T Driver Head 91-36571T Pilot Washer 91-37292 Roller Bearing 91-37311 Driver Head 91-37312 -Driver Head 91-37323 Driver Head Rod 91-37324 Pilot Washer 91-38628T Puller/Driver Head 91-52393 Driver Needle Bearing 91-52394 Head Pull Rod</p>
<p>Needle Bearing Driver</p>  <p>9443</p>	<p>91-33491</p> <p>Installs the needle bearing in the forward gear. Removes and installs the seals and bearing in the gimbal housing.</p>
<p>Slide Hammer</p>  <p>6761</p>	<p>91-34569A 1</p> <p>Aids in the removal of various engine components. Use with puller jaws.</p>

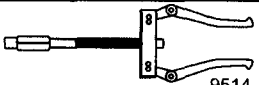
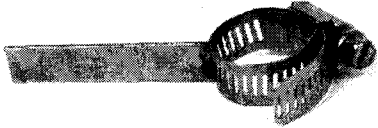
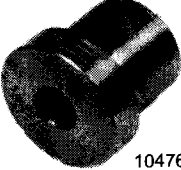
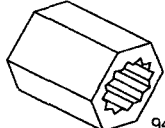
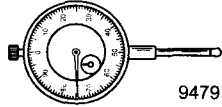
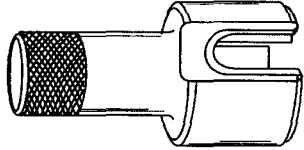
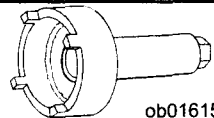
Driver Head	91-36569T
 <p>ob01634</p>	Used in pinion gear and bearing installation.
Pilot Washer	91-36571T
 <p>ob01619</p>	Used in pinion gear and pinion bearing installation.
Universal Puller Plate	91-37241
 <p>8505</p>	Removes bearings from gears and the driveshaft.
Driveshaft Bearing Driver Head	91-37312T
 <p>8762</p>	Removes bearings from gears and bearing carrier.
Driver Rod	91-37323
 <p>25431</p>	Used in pinion gear and pinion bearing installation.
Pilot Mandrel	91-37350T
 <p>8884</p>	Presses on inner race of forward gear roller bearing.
Puller/Driver Head	91-38628T
 <p>ob01622</p>	Used in pinion gear and pinion bearing installation.
Driveshaft Bearing Retainer Wrench	91-43506T
 <p>9520</p>	Removes and installs the threaded bearing retainer.

Section 1 - Two Stroke Models

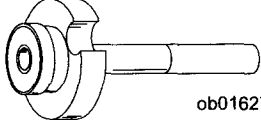
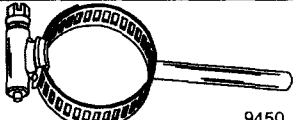
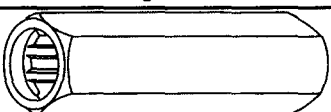
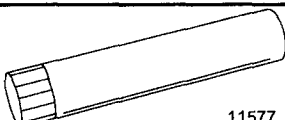
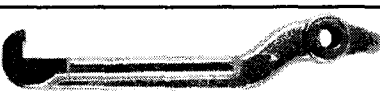
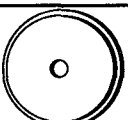

<p>Puller Jaws Assembly</p>  <p>9514</p>	<p>91-46086A1</p> <p>Removes bearing carrier and bearing races; use with Puller Bolt (91-85716).</p>
<p>Backlash Indicator Rod</p>  <p>10452</p>	<p>91-53459</p> <p>Aids in checking gear backlash.</p>
<p>Driver Head</p>  <p>10476</p>	<p>91-55919</p> <p>Removes bearings and seals; installs needle bearings into the bearing carrier.</p>
<p>Driveshaft Holding Tool</p>  <p>9448</p>	<p>91-56775T</p> <p>Provides a wrench surface to turn the driveshaft. Also used to hold driveshaft for pinion gear installation.</p>
<p>Dial Indicator</p>  <p>9479</p>	<p>91-58222A1</p> <p>Used to obtain a variety of measurements including gear backlash, pinion gear location, and TDC.</p>
<p>Pinion Nut Wrench</p>  <p>9593</p>	<p>91-61067A04</p> <p>Holds the pinion nut when removing the pinion gear and driveshaft. Also, use with Belleville washer and propeller nut to check the reverse gear lash.</p>
<p>Bearing Carrier Retainer Nut Wrench</p>  <p>ob01615</p>	<p>91-61069T</p> <p>Installs and removes the bearing carrier retainer nuts.</p>
<p>Propeller Shaft/Driveshaft Adapter</p>  <p>10805</p>	<p>91-61077T</p> <p>Provides a wrench surface to turn the propeller shaft or the driveshaft.</p>

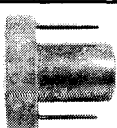
Section 1 - Two Stroke Models

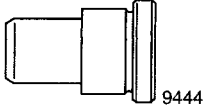
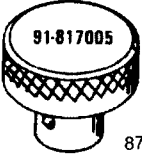
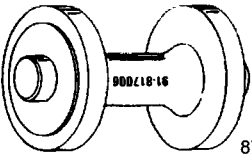
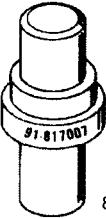
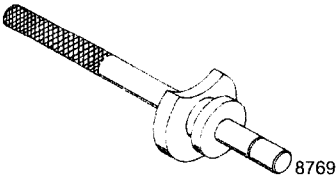
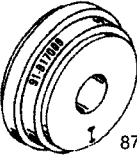
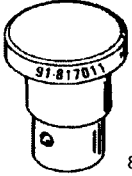

Torque Wrench, lb. in.	91-66274
 <p>10829</p>	Dial type torque wrench that sets torque from 9 to 150 lb. in.; 3/8 in. drive.
Pinion Height Tool	91-74776T
 <p>ob01627</p>	Checks pinion gear height.
Backlash Indicator Rod	91-78473
 <p>9450</p>	Aids in checking gear backlash.
Driveshaft Holding Tool	91-804776A1
 <p>12376</p>	Holds driveshaft while removing or torquing the pinion nut.
Forward Gear Assembly Tube	91-815850
 <p>11577</p>	Removes and installs the forward gear/bearing adapter assembly for counter rotation gearcases.
Puller Jaws	91-816242
 <p>10681</p>	Use with either the two prong or three prong puller on all drive units.
Guide Plate	91-816243
 <p>4481</p>	Centers the rod used to drive in the forward gear bearing on a standard rotation gearcase, and the reverse gear bearing on a counter rotation gearcase.
Reverse Gear Needle Bearing Driver	91-816244
 <p>10810</p>	Installs the needle bearings into the reverse gear of a counter rotating gearcase.
Needle Bearing Removal Tool	91-816245
 <p>10793</p>	Removes the needle bearings from the back adaptor of a counter rotating gearcase.

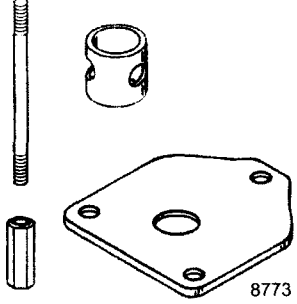
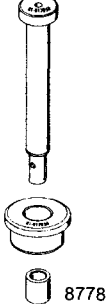
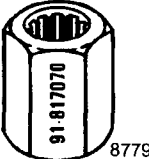
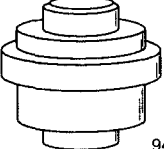
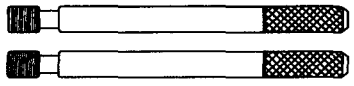

Section 1 - Two Stroke Models

<p>Needle Bearing Driver</p>  <p>9444</p>	<p>91-816292</p> <p>Installs the needle bearing onto the forward gear.</p>
<p>Forward Gear Bearing Installer</p>  <p>8763</p>	<p>91-817005</p> <p>Aids in the installation of the forward gear needle bearing.</p>
<p>Water Pump Base Seal Installer</p>  <p>8767</p>	<p>91-817006</p> <p>Installs upper and lower water pump base seals.</p>
<p>Bearing Carrier Seal Installer</p>  <p>8768</p>	<p>91-817007T</p> <p>Installs upper and lower bearing carrier seals.</p>
<p>Pinion Gear Location Tool</p>  <p>8769</p>	<p>91-817008A 2</p> <p>Checks gearcase pinion gear height.</p>
<p>Forward Gear Bearing Race Driver Cup</p>  <p>8771</p>	<p>91-817009T</p> <p>Aids in the installation of forward gear bearing race.</p>
<p>Needle Bearing Installer</p>  <p>8772</p>	<p>91-817011T</p> <p>Installs needle bearing in the bearing carrier.</p>

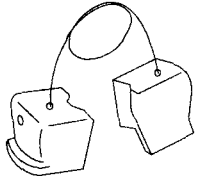
<p>Bearing Preload Tool Update Kit</p>	<p>91-817057A02</p>
 <p>8773</p>	<p>Use to update Bearing Preload Tool (91-14311A1).</p>
<p>Lower Driveshaft Bearing Driver Assembly</p>	<p>91-817058A 1</p>
 <p>8778</p>	<p>Removes and installs lower driveshaft bearing.</p>
<p>Driveshaft Holding Tool</p>	<p>91-817070</p>
 <p>8779</p>	<p>Holds driveshaft while removing pinion nut.</p>
<p>Carrier Seal Driver</p>	<p>91-817569T</p>
 <p>9481</p>	<p>Removes and installs the bearing carrier seals. Installs seals in the driveshaft seal carrier.</p>
<p>Water Pump Alignment Pins</p>	<p>91-821571A 1</p>
 <p>9482</p>	<p>Aligns the water pump during installation.</p>
<p>Seal/Bushing Installer</p>	<p>91-824785T 1</p>
 <p>13507</p>	<p>Aids in the installation of the bushing into the bearing carrier.</p>

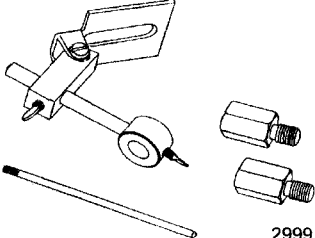
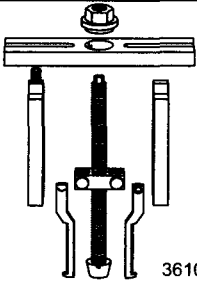
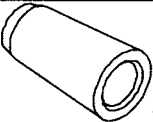
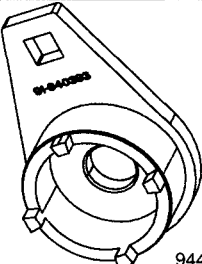
Section 1 - Two Stroke Models

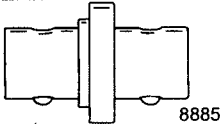
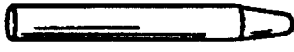
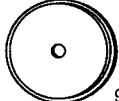
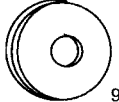
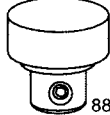
<p>Spring Hook</p>  <p>13666</p>	<p>91-825200A 1</p> <p>Aids in the removal of the pinion bearing race from the gearcase; use with driver (91-13779).</p>
<p>Driver</p>  <p>13667</p>	<p>91-826872</p> <p>Aids in the installation of the propeller shaft needle bearing into the forward gear.</p>
<p>Dial Indicator Adapter</p>  <p>2999</p>	<p>91-83155</p> <p>Attaches the dial indicator to the gearcase when checking backlash.</p>
<p>Bearing Puller Assembly</p>  <p>3610</p>	<p>91-83165T</p> <p>Removes bearings, races and bearing carriers</p>
<p>Bearing Carrier Installation Tool</p>  <p>9518</p>	<p>91-840388</p> <p>Installs the bearing carrier on heavy duty propeller shafts.</p>
<p>Bearing Carrier Retainer Nut Wrench</p>  <p>9449</p>	<p>91-840393</p> <p>Installs the bearing carrier retainer nut on heavy duty propeller shafts.</p>

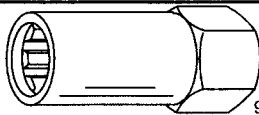
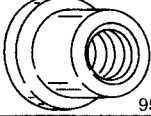
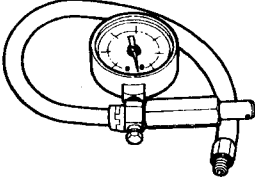
Bearing Driver	91-856875A 1
	Installs prop shaft needle bearing into 3 jaw or 6 jaw forward gear.
Cross Pin Tool	91-86642
	Aids in the installation of the cross pin into the clutch dog assembly.
Guide Plate	91-86943T
	Guides the forward gear bearing during installation.
Bearing Cup Driver	91-87120T
	Installs the forward gear bearing cup.
Bearing Driver	91-877321A 1
	Installs prop shaft needle bearing into 6 jaw forward gear.
Dial Indicator Holding Tool	91-89897
	Secures the dial indicator to gear housing when checking backlash.
Driveshaft Holding Tool	91-90094
	Assists in pinion gear installation.
Pinion Bearing Driver	91-92788T
	Aids in the removal and installation of the pinion bearing.
Leakage Tester Kit	FT8950
	Checks gear housing for leakage prior to filling with gear lubricant. Also used to pressurize the oil injection system.

Section 1 - Two Stroke Models

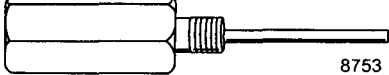
Expanding Rod	Snap-On CG40-4
 An illustration of a Snap-On CG40-4 Expanding Rod. It features a dark, cylindrical handle on the left, a black collet in the middle, and a long, thin metal rod extending to the right. The number 12538 is printed at the bottom right of the rod. <p>12538</p>	Aids in the removal of gears and bearings; use with collet.
Expanding Rod	Snap-On CG41-11
 An illustration of a Snap-On CG41-11 Expanding Rod. It consists of a long, thin metal rod with a threaded section near the left end, which is attached to a cylindrical component. The number 8753 is printed at the bottom right of the rod. <p>8753</p>	Aids in the removal of the spool from the power trim pump.

Section 2 - FourStroke Models

Table of Contents







Installation and Maintenance.....	36	Powerhead.....	48
Maintenance Tool Application Chart.....	36	Powerhead Tool Application Chart.....	48
Maintenance Tools.....	37	Powerhead Tools.....	49
Electrical and Ignition.....	40	Mid-Section.....	54
Electrical Tool Application Chart.....	40	Mid Section Tool Application Chart.....	54
Electrical Tools.....	41	Mid-Section Tools.....	55
Fuel System.....	45	Lower Unit.....	56
Fuel System Tool Application Chart.....	45	Gear Housing Tool Application Chart.....	56
Fuel System Tools.....	46	Gear Housing Tools.....	61

Installation and Maintenance

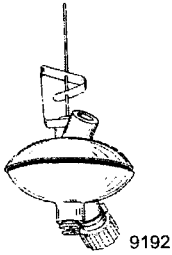

Maintenance Tool Application Chart

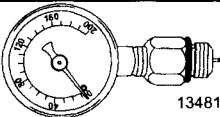
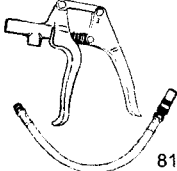

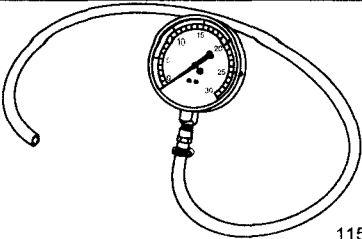

Part No.	Description	4/5/6	8/9.9 9.9 BigFoot	9.9/15	25 BigFoot	25/30 EFI	30/40 EFI	40-60 EFI	50/60	75/90	75/90 EFI	115 EFI	75-115 EFI 1.7 L	225 EFI
44357Q2	Flushing Device		X	X	X	X	X	X	X	X	X	X	X	X
17-49930A 1	Stainless Steel Tilt Pin							X	X	X	X	X	X	
22-86306A01	Adapter Bushing									X	X	X		
22-89772	Connector									X	X	X		
91-29287	Compression Tester	X	X	X	X	X	X	X	X					X
91-37299Q2	Grease Gun	X	X	X	X	X	X	X	X	X	X	X	X	X
91-52024A1	Remote Starter Switch		X	X	X	X	X	X	X	X	X	X	X	X
91-79250A 2	Water Pressure Gauge			X	X	X	X	X	X	X	X	X	X	X
91-802653Q02	Oil Filter Wrench			X	X			X	X	X	X	X		
91-83164M	Flywheel Puller/Lifting Ring		X	X	X	X	X	X	X	X	X	X		X
91-881834A1	Dual Fuel/Air Pressure Gauge Kit					X	X	X			X	X	X	X
91-883705T01	Lifting Strap													X
91-889277002	Oil Filter Wrench													X
91-889277Q01	Oil Filter Wrench												X	
91-895343T02	Flywheel Puller/Lifting Ring												X	
91-90265A5	Crankcase Oil Pump				X		X	X	X	X	X	X	X	X
91-98234A2	Transom Drilling Fixture									X	X	X	X	X
91-99750A1	DVA/ Multimeter Kit	X	X	X	X	X	X	X	X	X	X	X	X	X
Snap-On EEP303B	Compression Tester with Adapter	X	X	X	X	X	X	X	X	X	X	X	X	X
Snap-On EEP309A	Cylinder Leakage Tester	X	X	X	X	X	X	X	X	X	X	X	X	X

Maintenance Tools

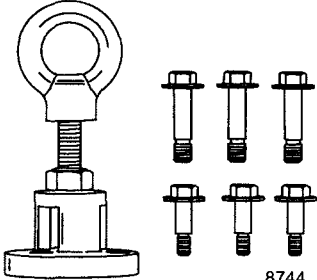
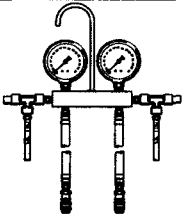
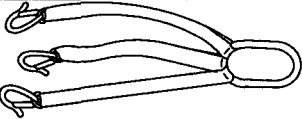
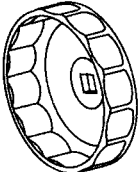
Flushing Device	44357Q 2
 <p>9192</p>	<p>Attaches to the water intakes; provides a fresh water connection when flushing the cooling system or operating the engine.</p>
Stainless Steel Tilt Pin	17-49930A 1
 <p>2749</p>	<p>Limits the down trim angle of the power trim equipped engines, or aids in determining the trim out angle on non-power trim engines.</p>
Adapter Bushing	22-86306A01
 <p>11600</p>	<p>Reduces thread size to install connector for checking cylinder block water pressure.</p>
Connector	22-89772
 <p>11601</p>	<p>Fitting for checking cylinder block water pressure.</p>
Compression Tester	91-29287
 <p>13481</p>	<p>Measures engine cylinder compression.</p>
Grease Gun	91-37299Q 2
 <p>8120</p>	<p>Aids in the lubrication of key areas on the engine. Allows easy access to grease fittings.</p>
Remote Starter Switch	91-52024A1
 <p>10882</p>	<p>Provides a remote starter button to crank the engine when performing service procedures.</p>

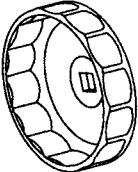
Section 2 - FourStroke Models

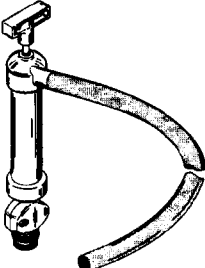
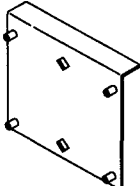
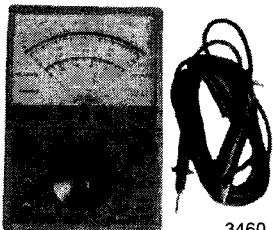
<p>Water Pressure Gauge</p>  <p>11598</p>	<p>91-79250A 2</p> <p>Aids in checking the engine water pressure.</p>
<p>Oil Filter Wrench</p>  <p>5221</p>	<p>91-802653Q02</p> <p>Assists in removal of oil filter.</p>
<p>Flywheel Puller/Lifting Ring</p>  <p>8744</p>	<p>91-83164M</p> <p>Removes flywheel from engine. Used for lifting powerhead/ engine.</p>
<p>Dual Fuel/Air Pressure Gauge Kit</p>  <p>5822</p>	<p>91-881834A 1</p> <p>Tests fuel and air pressure; the dual gauges allow the viewing of both pressures simultaneously.</p>
<p>Lifting Strap</p>  <p>25496</p>	<p>91-883705T01</p> <p>Aids in the removal and installation of the F225 engine.</p>
<p>Oil Filter Wrench</p>  <p>5221</p>	<p>91-889277002</p> <p>Aids in the removal of the oil filter.</p>

Oil Filter Wrench	91-889277Q01
 <p>5221</p>	Aids in the removal of the oil filter.
Flywheel Puller/Lifting Ring	91-895343T02
 <p>14869</p>	Removes flywheel from engine. Used for lifting powerhead/engine.
Crankcase Oil Pump	91-90265A 5
 <p>11591</p>	Aids in the removal of engine oil without draining the crankcase.
Transom Drilling Fixture	91-98234A2
 <p>5489</p>	Aids in engine installation by acting as a template for engine mounting holes.
DVA/Multimeter Kit	91-99750A 1
 <p>3460</p>	Tests the electrical and ignition systems; consists of a VOA meter with built-in direct voltage adapter.
Compression Tester with Adapter	Snap-On EEPV303B
 <p>8511</p>	Checks cylinder compression. Use with M14 x 1.25 adapter.

Section 2 - FourStroke Models

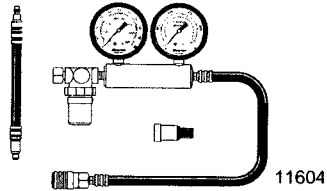
Cylinder Leakage Tester	Snap-On EEPV309A
	Aids in checking cylinder leakdown.

Electrical and Ignition



Electrical Tool Application Chart

Part No.	Description	4/5/6	8/9.9 9.9 Bigfoot	9.9/15	25 Bigfoot	25/30 EFI	30/40 EFI	40-60 EFI	50/60	75/90	75/90 EFI	115 EFI	75-115 EFI 1.7 L	225 EFI
84-822560A5	Adapter Harness				X		X	X	X					
84-822560A13	Adapter Harness												X	
84-825003A1	Extension Cable				X		X	X	X				X	X
91-24937A1	Flywheel Holder Strap	X												
91-52344	Flywheel Holding Tool												X	
91-58222A1	Dial Indicator	X	X	X	X	X	X	X	X	X	X	X		X
91-8026501	Clamp-on Current Probe		X	X	X	X	X	X	X	X	X	X	X	X
91-809871 2	New Style Vacuumate Carburetor Turner								X	X	X	X		X
91-83163M	Flywheel Holder		X		X	X	X	X	X	X	X	X		
91-83164M	Flywheel Puller/Lifting Ring	X	X		X	X	X	X	X	X	X	X		
91-850439T1	Spark Gap Tester	X	X	X	X	X	X	X	X	X	X	X	X	X
91-875216	Brush Holder										X	X		
91-881824001	Malfunction Indicator Lamp										X	X		X
91-881824004	Stator Coil Harness										X	X		
91-881825	Crank Position Sensor Test Harness											X		
91-881826	ECM (Coil Primary) Test Harness											X		



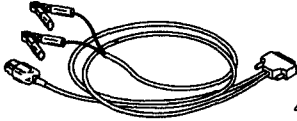

Section 2 - FourStroke Models

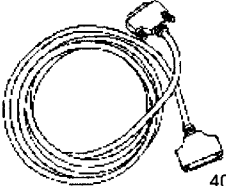

Part No.	Description	4/5/6	8/9.9 9.9 Bigfoot	9.9/15	25 Bigfoot	25/30 EFI	30/40 EFI	40-60 EFI	50/60	75/90	75/90 EFI	115 EFI	75-115 EFI 1.7 L	225 EFI
91-881827	Throttle Position Sensor Test Harness											X		
91-881828	Tamper-Proof Screw Torx Bit Set						X	X			X	X		X
91-89045 1	Direct Voltage Adapter	X	X	X	X	X	X	X	X	X	X	X		X
91-892647A01	DMT 2004 Digital Multimeter	X	X	X	X	X	X	X	X	X	X	X	X	X
91-895190	Flywheel Remover	X	X			X								
91-895191	Crankshaft Holding Tool		X											
91-895343T02	Flywheel/ Puller/Lifting Ring												X	
91-99379	Timing Light	X	X	X	X	X	X	X	X	X	X	X	X	X
91-99750A1	DVA/ Multimeter Kit	X	X							X	X	X	X	
Order through SPX	Computer Diagnostic System (CDS)				X	X	X	X	X				X	X

Electrical Tools

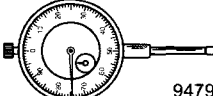

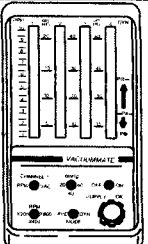
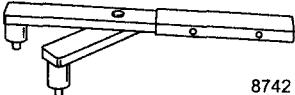
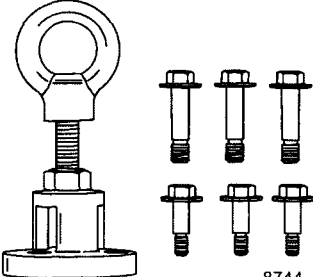
<p>Adapter Harness</p>  <p>4009</p>	<p>84-822560A5</p> <p>Data link harness between engine and Computer Diagnostic System (CDS) or Digital Diagnostic Terminal (DDT) on engines with a 2 pin diagnostic connection.</p>
<p>Adapter Harness</p>  <p>5826</p>	<p>84-822560A13</p> <p>Data link harness between engine and Computer Diagnostic System (CDS).</p>
<p>Extension Cable</p>  <p>4012</p>	<p>84-825003A1</p> <p>Data link extension harness (3.05 m[10 ft.]) between adapter harness and Digital Diagnostic Terminal</p>

Section 2 - FourStroke Models

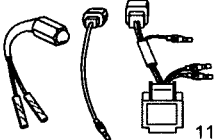
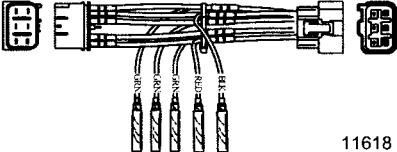
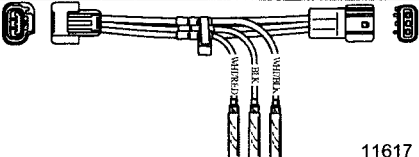
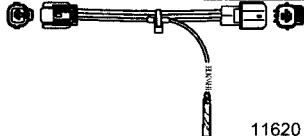
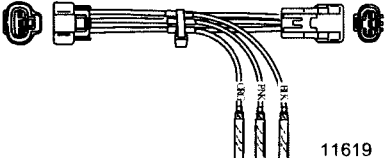
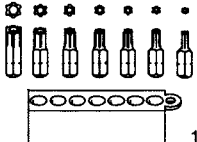
Flywheel Holder Strap	91-24937A 1
 <p>13446</p>	Holds the flywheel on manual start engines when removing the flywheel nut.
Flywheel Holding Tool	91-52344
 <p>4738</p>	Holds and/or turns the flywheel while making engine repairs, also used to torque the flywheel or the engine coupler.
Dial Indicator	91-58222A1
 <p>9479</p>	Used to obtain a variety of measurements including gear backlash, pinion gear location, and TDC.
Clamp-on Current Probe	91-802650-1
 <p>4006</p>	Measures the current output of battery charging systems or current draw of electric motors.
New Style Vacuumate Carburetor Tuner	91-809871 2
 <p>11630</p>	Allows the technician to balance the carburetors.
Flywheel Holder	91-83163M
 <p>8742</p>	Holds and/or turns the flywheel while making engine repairs, also used to torque the flywheel or the engine coupler.
Flywheel Puller/Lifting Ring	91-83164M
 <p>8744</p>	Removes flywheel from engine. Used for lifting powerhead/ engine.

<p>Spark Gap Tester</p>	<p>91-850439T 1</p>
 <p>7513</p>	<p>Provides a visual indication of spark/coil efficiency.</p>
<p>Brush Holder</p>	<p>91-875216</p>
 <p>11621</p>	<p>Holds the starter motor brushes in place when installing the armature.</p>
<p>Malfunction Indicator Lamp</p>	<p>91-881824001</p>
 <p>11625</p>	<p>Aids in engine diagnostics by displaying basic engine fault codes.</p>
<p>Stator Coil Harness</p>	<p>91-881824004</p>
 <p>11618</p>	<p>Links between the stator coil or the voltage regulator/rectifier and the main engine harness to check peak voltage.</p>
<p>Crank Position Sensor Test Harness</p>	<p>91-881825</p>
 <p>11617</p>	<p>Links between the crank position sensor and the main engine harness to check the crank position sensor signal.</p>
<p>ECM (Coil Primary) Test Harness</p>	<p>91-881826</p>
 <p>11620</p>	<p>Links between the ignition coil and the main engine harness to measure the peak voltage going from the Electronic Control Module to the ignition coil.</p>
<p>Throttle Position Sensor Test Harness</p>	<p>91-881827</p>
 <p>11619</p>	<p>Links between the throttle position sensor and the main engine harness to check the throttle position sensor signal.</p>
<p>Tamper-Proof Screw Torx Bit Set</p>	<p>91-881828</p>
 <p>11782</p>	<p>Aids in the removal of tamper-proof fasteners.</p>

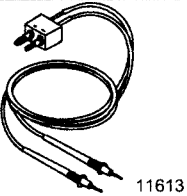
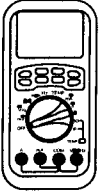
Section 2 - FourStroke Models

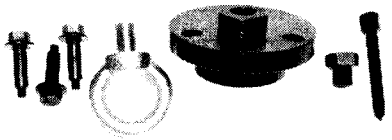
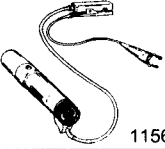
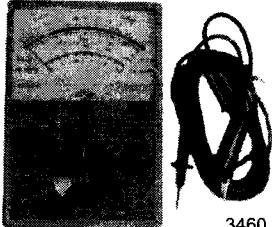
Direct Voltage Adapter	91-89045 1
 <p>11613</p>	Use with a multimeter to check peak voltage on various engine components.
DMT 2004 Digital Multimeter	91-892647A01
 <p>4516</p>	Measures RPM on spark ignition (SI) engines, ohms, amperes, AC and DC voltages; records maximums and minimums simultaneously, and accurately reads in high RFI environments.
Flywheel Remover	91-895190
 <p>3458</p>	Aids in the removal of the flywheel.
Crankshaft Holding Tool	91-895191
 <p>3455</p>	Holds crankshaft while servicing the powerhead.
Flywheel Puller/Lifting Ring	91-895343T02
 <p>14869</p>	Removes flywheel from engine. Used for lifting powerhead/engine.
Timing Light	91-99379
 <p>11561</p>	Allows a technician to check ignition timing.
DVA/Multimeter Kit	91-99750A 1
 <p>3460</p>	Tests the electrical and ignition systems; consists of a VOA meter with built-in direct voltage adapter.

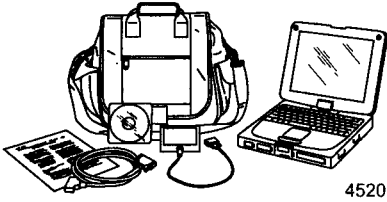

Computer Diagnostic System (CDS)	Order through SPX
	<p>Monitors all electrical systems for proper function, diagnostics, and calibration purposes. For additional information, pricing, or to order the Computer Diagnostic System contact:</p> <p>SPX Corporation 28635 Mound Rd. Warren, MI 48092 or call: USA - 1-800-345-2233 Canada - 800-345-2233 Europe - 49 6182 959 149 Australia - (03) 9544-6222</p>

Fuel System

Fuel System Tool Application Chart

Part No.	Description	25 Bigfoot	25/30 EFI	30/40 EFI	40-60 EFI	50/60	75/90	75/90 EFI	115 EFI	75-115 EFI 1.7 L	225 EFI
99056A1	Malfunction Indicator Lamp								X		X
84-822560A5	Adapter Harness			X	X					X	
84-822560A13	Adapter Harness									X	
84-822560T12	2 to 4 Pin Harness Adapter			X	X					X	
84-825003A1	Extension Cale	X		X	X	X				X	
91-803146A04	Hose Clamp Tool Kit	X	X	X	X	X				X	X
91-881824003	Fuel Pressure Gauge Adapter							X			
91-881828	Tamper-Proof Screw Torx Bit Set			X	X			X	X		X
91-881833A03	Fuel Pressure Gauge Kit		X	X	X			X	X	X	X
91-881834A1	Dual Fuel/Air Pressure Gauge Kit		X	X	X			X	X	X	X
91-884793A1	Diagnostic Lamp								X		
91-892647A01	DMT 2004 Digital Multimeter	X	X	X	X	X	X	X	X	X	X
91-892651A01	Digital Pressure Meter		X	X	X			X	X	X	X
Order through SPX	Computer Diagnostic System (CDS)	X	X	X	X	X		X	X	X	

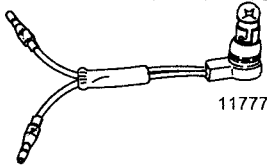
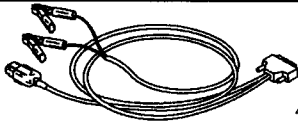
Fuel System Tools

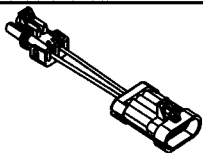
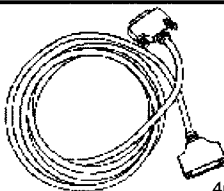
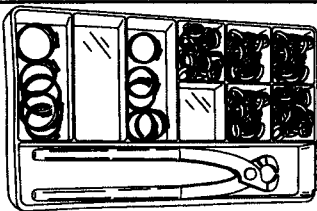
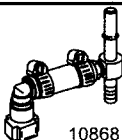
<p>Malfunction Indicator Lamp</p>	<p>99056A 1</p>
 <p>11777</p>	<p>Aids in engine diagnostics by displaying basic engine fault codes.</p>
<p>Adapter Harness</p>	<p>84-822560A5</p>
 <p>4009</p>	<p>Data link harness between engine and Computer Diagnostic System (CDS) or Digital Diagnostic Terminal (DDT) on engines with a 2 pin diagnostic connection.</p>
<p>Adapter Harness</p>	<p>84-822560A13</p>
 <p>5826</p>	<p>Data link harness between engine and Computer Diagnostic System (CDS).</p>
<p>2 to 4 Pin Harness Adapter</p>	<p>84-822560T12</p>
 <p>4679</p>	<p>Adapts the 2 pin Digital Diagnostic Terminal harness to the 4 pin connector on the engine.</p>
<p>Extension Cable</p>	<p>84-825003A1</p>
 <p>4012</p>	<p>Data link extension harness (3.05 m[10 ft.]) between the adapter harness and the Digital Diagnostic Terminal or Computer Diagnostic System (CDS).</p>
<p>Hose Clamp Tool Kit</p>	<p>91-803146A04</p>
 <p>5819</p>	<p>Aids in the installation of high pressure (Oetiker®) hose clamps.</p>
<p>Fuel Pressure Gauge Adapter</p>	<p>91-881824003</p>
 <p>10868</p>	<p>Connects the fuel pressure gauge to the fuel rail when checking fuel pressure.</p>

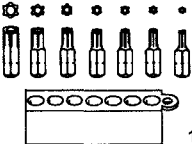
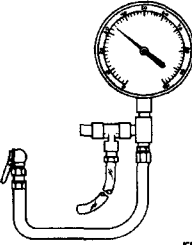
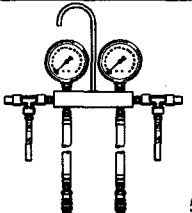
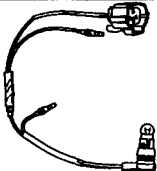
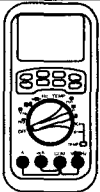
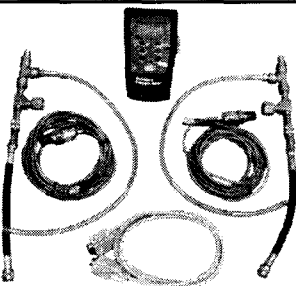
<p>Tamper-Proof Screw Torx Bit Set</p>	<p>91-881828</p>
 <p>11782</p>	<p>Aids in the removal of tamper-proof fasteners.</p>
<p>Fuel Pressure Gauge Kit</p>	<p>91-881833A03</p>
 <p>rms32</p>	<p>Tests the fuel pump pressure; can be used to relieve fuel pressure.</p>
<p>Dual Fuel/Air Pressure Gauge Kit</p>	<p>91-881834A 1</p>
 <p>5822</p>	<p>Tests fuel and air pressure; the dual gauges allow the viewing of both pressures simultaneously.</p>
<p>Diagnostic Lamp</p>	<p>91-884793A 1</p>
 <p>11780</p>	<p>Aids in engine diagnostics by displaying basic engine fault codes.</p>
<p>DMT 2004 Digital Multimeter</p>	<p>91-892647A01</p>
 <p>4516</p>	<p>Measures RPM on spark ignition (SI) engines, ohms, amperes, AC and DC voltages; records maximums and minimums simultaneously, and accurately reads in high RFI environments.</p>
<p>Digital Pressure Meter</p>	<p>91-892651A01</p>
 <p>5786</p>	<p>Connects to the fuel system/manifold and can be used in conjunction with Computer Diagnostic System (CDS).</p>

Section 2 - FourStroke Models

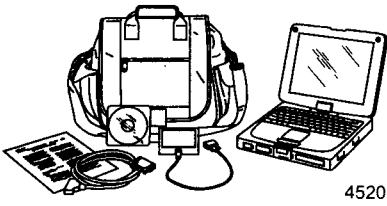
Computer Diagnostic System (CDS)	Order through SPX
 <p style="text-align: right;">4520</p>	<p>Monitors all electrical systems for proper function, diagnostics, and calibration purposes. For additional information, pricing, or to order the Computer Diagnostic System contact:</p> <p>SPX Corporation 28635 Mound Rd. Warren, MI 48092 or call: USA - 1-800-345-2233 Canada - 800-345-2233 Europe - 49 6182 959 149 Australia - (03) 9544-6222</p>

Powerhead

Powerhead Tool Application Chart





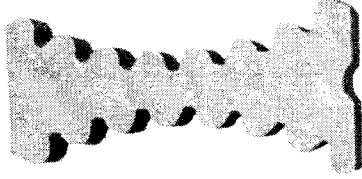

Part No.	Description	4/5/6	8/9.9 9.9 BigFoot	9.9/15	25 Bigfoot	25/30 EFI	30/40 EFI	40-60 EFI	50/60	75/90	75/90 EFI	115 EFI	75-115 EFI 1.7 L	225 EFI
N/A	Cam Brake												X	
N/A	Crankshaft Retainer												X	
N/A	Dial Indicator Extension Adapter												X	
N/A	Ring Compressor												X	
N/A	Rod Guide Dowel												X	
22-883147	Adapter Fitting									X	X	X		X
91-13662T1	Powerhead Stand		X											
91-24697	Piston Ring Expander	X	X	X	X	X	X	X	X	X	X	X	X	X
91-802653Q02	Oil Filter Wrench		X		X	X	X	X	X	X	X	X		
91-803146A04	Hose Clamp Tool Kit												X	
91-804770A1	Crankshaft Holder									X	X	X		
91-804774001	Valve Guide Remover/ Installer									X	X	X		
91-804775	Valve Guide Reamer									X	X	X		
91-809494A1	Valve Spring Compressor		X	X	X	X	X	X	X	X	X	X	X	X
91-809495A1	Valve Guide Driver		X		X		X	X	X					
91-809496A1	Valve Guide Driver Bushing		X		X		X	X	X					





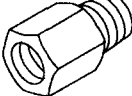
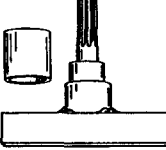
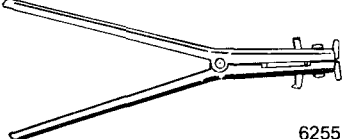

Part No.	Description	4/5/6	8/9.9 9.9 BigFoot	9.9/15	25 Bigfoot	25/30 EFI	30/40 EFI	40-60 EFI	50/60	75/90	75/90 EFI	115 EFI	75-115 EFI 1.7 L	225 EFI
91-809646A1	1-5/8 Socket								X					
91-809905001	13 mm Torque Adapter												X	
91-827001A1	Powerhead Stand				X		X	X	X					
91-83163M	Flywheel Holder		X		X		X	X	X	X	X	X		X
91-83164M	Flywheel Puller/Lifting Ring		X		X		X	X	X	X	X	X		X
91-83165T	Bearing Puller Assembly	X		X			X	X	X	X				
91-881833A03	Fuel Pressure Gauge Kit												X	
91-881834A1	Dual Fuel/Air Pressure Gauge Kit									X	X	X	X	
91-881847T	46 mm Socket									X	X	X		
91-883705T01	Lifting Strap													X
91-889277002	Oil Filter Wrench													X
91-889277Q01	Oil Filter Wrench												X	
91-892651A01	Digital Pressure Meter									X	X	X	X	
91-895191	Crankshaft Holding Tool		X											
91-895192	Piston Ring Compressor Tool		X											
FT2997	Piston Ring Compressor	X	X	X	X	X	X	X	X	X	X	X	X	X

Powerhead Tools

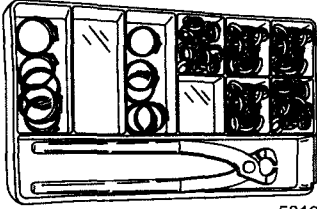
Cam Brake	Part number not available for this printing.
 <p>5539</p>	Prevents the intake and exhaust cam from turning while removing or installing cam retaining bolts.

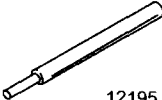
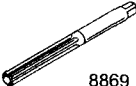
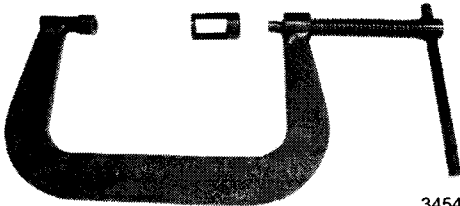
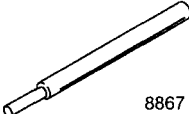
Section 2 - FourStroke Models

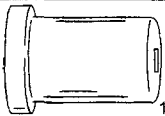
<p>Crankshaft Retainer</p>  <p>6191</p>	<p>Part number not available for this printing.</p> <p>Secures crankshaft to cylinder block while rotating block to install the cylinder head.</p>
<p>Dial Indicator Extension Adapter</p>  <p>4719</p>	<p>Part number not available for this printing.</p> <p>Extends the dial indicators reach.</p>
<p>Ring Compressor</p>  <p>4739</p>	<p>Part number not available for this printing</p> <p>Compresses piston rings when installing the piston into the cylinder block.</p>
<p>Rod Guide Dowel</p>  <p>4735</p>	<p>Part number not available for this printing.</p> <p>Prevents cylinder bore and crankshaft from damage while installing or removing connecting rod assembly.</p>
<p>Adapter Fitting</p>  <p>12201</p>	<p>22-883147</p> <p>Adapts British Standard Pipe Thread (BSPT) to National Pipe Thread Fitting (NPTF) when checking oil pressure.</p>
<p>Powerhead Stand</p>  <p>13477</p>	<p>91-13662T 1</p> <p>Used to secure and rotate the powerhead during disassembly and assembly.</p>
<p>Piston Ring Expander</p>  <p>6255</p>	<p>91-24697</p> <p>Expands piston rings for removal and installation.</p>
<p>Oil Filter Wrench</p>  <p>5221</p>	<p>91-802653Q02</p> <p>Assists in removal of oil filter.</p>

<p>Hose Clamp Tool Kit</p>  <p>5819</p>	<p>91-803146A04</p> <p>Aids in the installation of high pressure (Oetiker ®) hose clamps.</p>
<p>Crankshaft Holder</p>  <p>12199</p>	<p>91-804770A 1</p> <p>Holds crankshaft while servicing the powerhead.</p>
<p>Valve Guide Remover/Installer</p>  <p>12195</p>	<p>91-804774001</p> <p>Removes and installs valve guides.</p>
<p>Valve Guide Reamer</p>  <p>8869</p>	<p>91-804775</p> <p>Use to ream valve guides out to proper size.</p>
<p>Valve Spring Compressor</p>  <p>3454</p>	<p>91-809494A1</p> <p>Removes and installs valve springs.</p>
<p>Valve Guide Driver</p>  <p>8867</p>	<p>91-809495A 1</p> <p>Removes and installs valve guides.</p>
<p>Valve Guide Driver Bushing</p>  <p>8868</p>	<p>91-809496A 1</p> <p>Limits depth of valve guide installation.</p>
<p>1-5/8 Socket</p>  <p>13492</p>	<p>91-809646A1</p> <p>Aids in the removal of the crankshaft timing gear nut.</p>
<p>13 mm Torque Adapter</p>  <p>4631</p>	<p>91-809905001</p> <p>Aids in the removal and installation of powerhead nuts, and torquing nuts to specification.</p>

Section 2 - FourStroke Models

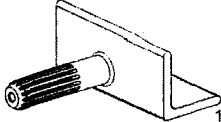
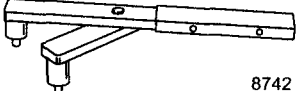
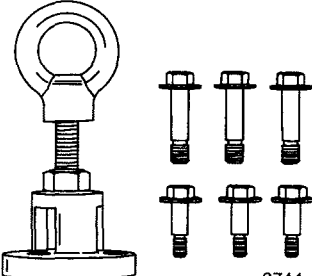
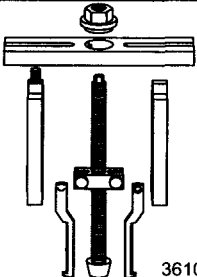
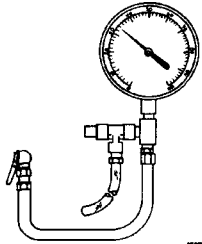
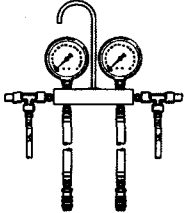
<p>Powerhead Stand</p>  <p>13494</p>	<p>91-827001A 1</p> <p>Used to secure and rotate the powerhead during disassembly and assembly.</p>
<p>Flywheel Holder</p>  <p>8742</p>	<p>91-83163M</p> <p>Holds and/or turns the flywheel while making engine repairs, also used to torque the flywheel or the engine coupler.</p>
<p>Flywheel Puller/Lifting Ring</p>  <p>8744</p>	<p>91-83164M</p> <p>Removes flywheel from engine. Used for lifting powerhead/engine.</p>
<p>Bearing Puller Assembly</p>  <p>3610</p>	<p>91-83165T</p> <p>Removes bearings, races and bearing carriers</p>
<p>Fuel Pressure Gauge Kit</p>  <p>rms32</p>	<p>91-881833A03</p> <p>Tests the fuel pump pressure; can be used to relieve fuel pressure.</p>
<p>Dual Fuel/Air Pressure Gauge Kit</p>  <p>5822</p>	<p>91-881834A 1</p> <p>Tests fuel and air pressure; the dual gauges allow the viewing of both pressures simultaneously.</p>

Personnel should not work on or under an engine that is suspended. Engines should be attached to work stands, or lowered to ground as soon as possible.

TABLE OF CONTENTS

Section 1 - Two Stroke Models

Installation and Maintenance.....	2	Powerhead.....	11
Maintenance Tool Application Chart.....	2	Powerhead Tool Application Chart.....	11
Maintenance Tools.....	2	Powerhead Tools.....	13
Electrical.....	3	Mid-Section.....	17
Electrical Tool Application Chart.....	3	Mid-Section Tool Application Chart.....	17
Electrical Tools.....	4	Mid-Section Tools.....	18
Fuel System.....	8	Lower Unit.....	20
Fuel System Tool Application Chart.....	8	Gear Housing Tool Application Chart.....	20
Fuel System Tools.....	9	Gear Housing Tools.....	23

Section 2 - FourStroke Models

Installation and Maintenance.....	36	Powerhead.....	48
Maintenance Tool Application Chart.....	36	Powerhead Tool Application Chart.....	48
Maintenance Tools.....	37	Powerhead Tools.....	49
Electrical and Ignition.....	40	Mid-Section.....	54
Electrical Tool Application Chart.....	40	Mid Section Tool Application Chart.....	54
Electrical Tools.....	41	Mid-Section Tools.....	55
Fuel System.....	45	Lower Unit.....	56
Fuel System Tool Application Chart.....	45	Gear Housing Tool Application Chart.....	56
Fuel System Tools.....	46	Gear Housing Tools.....	61

Section 3 - OptiMax Models

Installation and Maintenance.....	76	Powerhead.....	82
Maintenance Tool Application Chart.....	76	Powerhead Tool Application Chart.....	82
Maintenance Tools.....	76	Powerhead Tools.....	83
Electrical and Ignition.....	77	Mid-Section.....	85
Electrical Tool Application Chart.....	77	Mid-Section Tool Application Chart.....	85
Electrical Tools.....	77	Mid-Section Tools.....	86
Fuel System.....	79	Lower Unit.....	87
Fuel System Tool Application Chart.....	79	Gear Housing Tool Application Chart.....	87
Fuel System Tools.....	80	Gear Housing Tools.....	90

Section 4 - Verado Models

Installation and Maintenance.....	100	Fuel System Tool Application Chart.....	103
Maintenance Tool Application Chart.....	100	Fuel System Tools.....	103
Maintenance Tools.....	100	Powerhead.....	105
Electrical and Ignition.....	102	Powerhead Tool Application Chart.....	105
Electrical Tool Application Chart.....	102	Powerhead Tools.....	106
Electrical Tools.....	102	Mid-Section.....	108
Fuel System.....	103	Mid-Section Tool Application Chart.....	108





Mid-Section Tools.....	108	Power Steering.....	115
Lower Unit.....	110	Power Steering Tool Application Chart.....	115
Gear Housing Tool Application Chart.....	110	Power Steering Tools.....	116
Gear Housing Tools.....	111		

Section 5 - SmartCraft and Digital Throttle & Shift

SmartCraft and Digital Throttle and Shift (DTS) Tool Application Chart.....	118	Computer Diagnostic System Adapter Cable Application Chart.....	121
Special Tools/Cables.....	118	Computer Diagnostic System Adapter Cables...	122
SmartCraft and Digital Throttle and Shift Tools..	119		

Section 6 - Sport Jet Pump Models

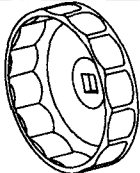
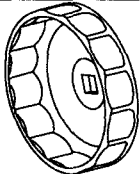
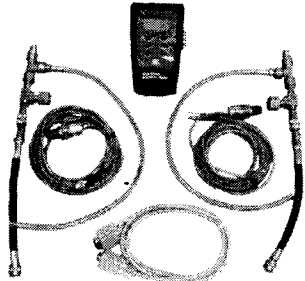
Sport Jet Pump Tool Application Chart.....	126	Sport Jet Pump Tools.....	127
--	-----	---------------------------	-----

<p>46 mm Socket</p>  <p>12200</p>	<p>91-881847T</p> <p>Aids in the removal and torquing of the flywheel.</p>
<p>Lifting Strap</p>  <p>25496</p>	<p>91-883705T01</p> <p>Aids in the removal and installation of the F225 engine.</p>
<p>Oil Filter Wrench</p>  <p>5221</p>	<p>91-889277002</p> <p>Aids in the removal of the oil filter.</p>
<p>Oil Filter Wrench</p>  <p>5221</p>	<p>91-889277Q01</p> <p>Aids in the removal of the oil filter.</p>
<p>Digital Pressure Meter</p>  <p>5786</p>	<p>91-892651A01</p> <p>Connects to the fuel system/manifold and can be used in conjunction with Computer Diagnostic System (CDS).</p>
<p>Crankshaft Holding Tool</p>  <p>3455</p>	<p>91-895191</p> <p>Holds crankshaft while servicing the powerhead.</p>
<p>Piston Ring Compressor Tool</p>  <p>3456</p>	<p>91-895192</p> <p>Compresses piston rings for easy piston installation.</p>

Section 2 - FourStroke Models

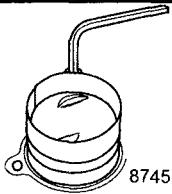
Piston Ring Compressor	FT2997
	Compresses the piston rings to ease piston installation.

Mid-Section



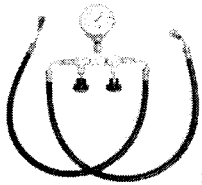
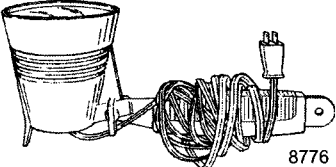
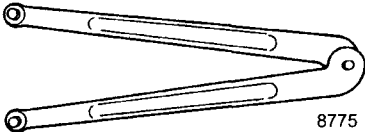
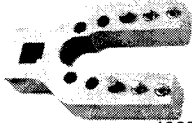
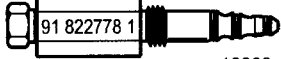
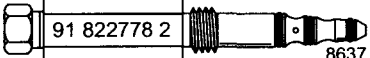
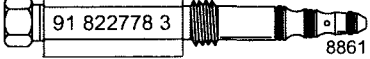
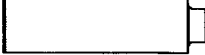

Mid Section Tool Application Chart

Part No.	Description	8/9.9 9.9 BigFoot	9.9/15	25 BigFoot	25/30 EFI	30/40 EFI	40-60 EFI	50/60	75/90	75/90 EFI	115 EFI	75-115 EFI 1.7 L	225 EFI
91-52915A6	Power Trim Test Gauge Kit					X	X	X	X	X	X	X	X
91-63209	Torch Lamp				X	X	X	X	X	X	X	X	
91-74951	Spanner Wrench			X		X	X	X	X	X	X	X	
91-821709T	Trim Cylinder End Cap Tool			X		X	X	X	X	X	X	X	
91-822778A1	Adapter Fitting			X			X	X					
91-822778A2	Adapter Fitting			X			X	X					
91-822778A 3	Adapter Fitting			X			X	X	X	X	X	X	
91-875215	Driveshaft Bushing Installer Tool								X	X	X		
91-892647A01	DMT 2004 Digital Multimeter	X	X	X	X	X	X	X	X	X	X	X	X
91-99750A 1	DVA/ Multimeter Kit			X			X	X	X	X	X		X
Snap-On CG41-11	Expanding Rod			X		X	X	X	X	X	X	X	
Snap-On CG41-14	Collet					X	X	X	X	X	X	X	
Snap-On SRP-2	Lock-Ring Pliers			X		X							
Snap-On SRP-4	Lock-Ring Pliers						X	X	X	X	X	X	X

Mid-Section Tools

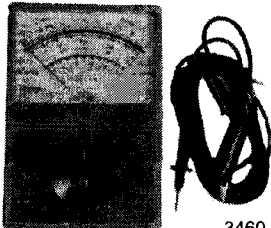
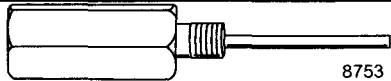
Power Trim Test Gauge Kit	91-52915A6
 <p>3753</p>	Tests circuit pressures for various trim pumps.
Torch Lamp	91-63209
 <p>8776</p>	Heats surfaces to aid in the removal and installation of interference fit engine components.
Spanner Wrench	91-74951
 <p>8775</p>	Removes and installs trim cylinder end caps.
Trim Cylinder End Cap Tool	91-821709T
 <p>10691</p>	Allows easy removal of the trim cylinder end caps. Required if tilt limit spacers are to be installed or if the trim in limit spacer is to be removed (to allow additional trim in range).
Adapter Fitting	91-822778A 1
 <p>12203</p>	Measures the internal pressure in the up mode for a single cylinder trim system.
Adapter Fitting	91-822778A 2
 <p>8637</p>	Install in place of the manual release valve to measure the internal pressure of the power trim pump in the up mode.
Adapter Fitting	91-822778A 3
 <p>8861</p>	Install in place of the manual release valve to measure the internal pressure of the power trim pump in the down mode.
Driveshaft Bushing Intaller Tool	91-875215
 <p>12202</p>	Aids in the installation of driveshaft bushings.

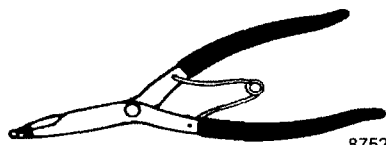
Section 2 - FourStroke Models

DMT 2004 Digital Multimeter	91-892647A01
 <p>4516</p>	<p>Measures RPM on spark ignition (SI) engines, ohms, amperes, AC and DC voltages; records maximums and minimums simultaneously, and accurately reads in high RFI environments.</p>
DVA/Multimeter Kit	91-99750A 1
 <p>3460</p>	<p>Tests the electrical and ignition systems; consists of a VOA meter with built-in direct voltage adapter.</p>
Expanding Rod	Snap-On CG41-11
 <p>8753</p>	<p>Aids in the removal of the spool from the power trim pump.</p>
Collet	Snap-On CG41-14
 <p>8754</p>	<p>Aids in the removal of the spool from the power trim pump.</p>
Lock-Ring Pliers	Snap-On SRP2
 <p>8752</p>	<p>Removes and installs external snap rings and piston rings.</p>
Lock-Ring Pliers	Snap-On SRP-4
 <p>4799</p>	<p>Aids in the removal of lock rings.</p>

Lower Unit

Gear Housing Tool Application Chart

Part No.	Description	4/5/6	8/9.9 9.9 Bigfoot	9.9/15	25 Bigfoot	25/30 EFI	30/40 EFI	40-60 EFI	50/60	75/90	75/90 EFI	115 EFI	75-115 EFI 1.7 L	225 EFI
12-34961	Washer				X		X	X	X					

Section 2 - FourStroke Models

Part No.	Description	4/5/6	8/9.9 9.9 Bigfoot	9.9/15	25 Bigfoot	25/30 EFI	30/40 EFI	40-60 EFI	50/60	75/90	75/90 EFI	115 EFI	75-115 EFI 1.7 L	225 EFI
91-12349A05	Pinion Gear Locating Tool						X	X	X	X	X	X	X	
91-13658T	Mandrel			X										
91-13945	Bearing Installation Driver						X	X	X	X	X	X	X	
91-13949	Oil Seal Driver				X		X	X	X	X	X	X	X	
91-14308T02	Bearing Race Driver				X		X	X	X	X	X	X	X	
91-14309T02	Bearing Installation Puller				X		X	X	X	X	X	X	X	
91-14310T1	Wear Sleeve Driver				X		X	X	X	X	X	X	X	
91-14311A04	Bearing Preload Tool				X		X	X	X	X	X	X	X	
91-15755T	Needle Bearing Driver				X		X	X	X	X	X	X		
91-19660-1	Backlash Indicator				X		X	X	X	X	X	X	X	
91-27780	Puller	X	X	X	X		X	X	X					
91-29310	Puller Plate													X
91-31106T	Bearing Cup Driver				X		X	X	X	X	X	X	X	
91-31108T	Oil Seal Driver				X	X	X	X	X	X	X	X	X	
91-31229A7	Bearing Removal and Installation Kit		X	X	X		X	X	X	X	X	X	X	
91-34569A1	Slide Hammer		X	X	X	X	X	X	X	X	X	X	X	X
91-36569T	Driver Head				X		X	X	X	X	X	X		
91-36571T	Pilot Washer		X	X	X		X							
91-37241	Universal Puller Plate		X	X	X	X	X	X	X	X	X	X	X	X
91-37312T	Driveshaft Bearing Driver Head				X		X	X	X					
91-37323	Driver Rod				X		X	X	X	X	X	X	X	X
91-37350T	Pilot Mandrel				X		X	X	X	X	X	X	X	

Section 2 - FourStroke Models

Part No.	Description	4/5/6	8/9.9 9.9 Bigfoot	9.9/15	25 Bigfoot	25/30 EFI	30/40 EFI	40-60 EFI	50/60	75/90	75/90 EFI	115 EFI	75-115 EFI 1.7 L	225 EFI
91-43506T	Driveshaft Bearing Retainer Wrench							X	X					
91-46086A1	Puller Jaws Assembly				X		X	X	X	X	X	X	X	X
91-56775T	Driveshaft Holding Tool				X		X	X	X					
91-58222A1	Dial Indicator		X		X	X	X	X	X	X	X	X	X	X
91-63209	Torch Lamp		X			X								
91-78473	Backlash Indicator Rod				X		X	X	X	X	X			
91-803133 12	Backlash Indicator Arm		X			X								
91-804762	Driveshaft Holding Tool		X											
91-804776A1	Driveshaft Holding Tool						X	X	X	X	X	X		
91-817005	Forward Gear Bearing Installer						X	X	X					
91-817006	Water Pump Base Seal Installer						X	X	X					
91-817007T	Bearing Carrier Seal Installer				X		X	X	X					
91-817008A2	Pinion Gear Location Tool						X	X	X					
91-817009T	Forward Gear Bearing Race Driver Cup						X	X	X					
91-817011T	Needle Bearing Installer				X		X	X	X					
91-817057A02	Bearing Preload Tool Update Kit						X	X	X					
91-817058A1	Lower Driveshaft Bearing Driver Assembly						X	X	X					
91-817070	Driveshaft Holding Tool						X	X	X	X	X			

Part No.	Description	4/5/6	8/9.9 9.9 Bigfoot	9.9/15	25 Bigfoot	25/30 EFI	30/40 EFI	40-60 EFI	50/60	75/90	75/90 EFI	115 EFI	75-115 EFI 1.7 L	225 EFI
91-824785T1	Seal/ Bushings Installer		X											
91-825198	Mandrel													X
91-825200A1	Spring Hook				X	X	X							
91-826872	Driver				X		X							
91-83155	Dial Indicator Adapter		X			X	X	X	X	X	X	X	X	X
91-83164M	Flywheel Puller/Lifting Ring													X
91-83165T	Bearing Puller Assembly	X	X	X		X	X	X	X	X	X	X	X	
91-83166M	Bearing Mandrel Kit		X			X								
91-853996-6	Spring Pin Removal Tool		X											
91-853996 8	Spring Pin Driver		X											
91-853996 12	Pinion Nut Tool					X								
91-853996 14	Driveshaft Holding Tool					X								
91-856875A1	Bearing Driver						X	X	X	X	X	X	X	
91-86642-1	Slotted Cross Pin Tool									X	X		X	
91-875215A1	Driveshaft Bushings Installation Tool													
91-877321A1	Bearing Driver						X	X	X	X	X	X		
91-877840A1	Driveshaft Holding Tool						X	X	X					
91-888870 (stamped 06605)	Driver Rod													X
91-888875T	Pinion Height Gage													X
91-888877	Shift Rod													X
91-888878	Backlash Indicator Tool													X

Section 2 - FourStroke Models

Part No.	Description	4/5/6	8/9.9 9.9 Bigfoot	9.9/15	25 Bigfoot	25/30 EFI	30/40 EFI	40-60 EFI	50/60	75/90	75/90 EFI	115 EFI	75-115 EFI 1.7 L	225 EFI
91-888879 (stamped 06514)	Propeller Shaft Adapter													X
91-888880T (stamped 06578)	Spanner Wrench													X
91-888881 (stamped 06653)	Mandrel													X
91-888882 (stamped 06652)	Driver Rod													X
91-888883 (stamped 06604)	Driver Rod with Stop													X
91-888884 (stamped 06610)	Mandrel													X
91-888885 (stamped 06603)	Bearing Depth Plate													X
91-888886 (stamped 06656)	Mandrel													X
91-888887 (stamped 06606)	Driver Rod													X
91-888888 (stamped 06622)	Mandrel													X
91-888889	Driveshaft Holding Tool													X
91-888890 (stamped 06636)	Mandrel													X
91-888891 (stamped 06658)	Mandrel													X
91-888892 (stamped 06628)	Mandrel													X
91-888893 (stamped 06659)	Mandrel					X								X
91-888894 (stamped 06577)	Mandrel													X
91-889586 (stamped 06701)	Shimming Plate													X
91-88958T	Driveshaft Holding Tool												X	

Part No.	Description	4/5/6	8/9.9 9.9 Bigfoot	9.9/15	25 Bigfoot	25/30 EFI	30/40 EFI	40-60 EFI	50/60	75/90	75/90 EFI	115 EFI	75-115 EFI 1.7 L	225 EFI
91-895195	Pinion Bearing Tool		X											
91-895195001	Bearing Installation Tool		X			X								
91-895195004	Backlash Preload Tool		X			X								
91-895218	Pinion Height Tool					X								
FT8950	Leakage Tester Kit			X	X		X						X	
Snap-On CG40-4	Expanding Rod		X	X										
Snap-On CG40A-6	Collet		X	X										

Gear Housing Tools

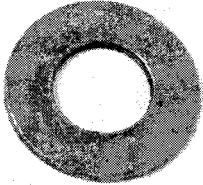

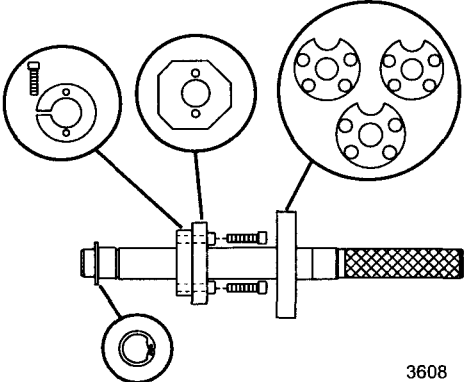

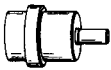
Washer	12-34961
 <p>10834</p>	Use on the threaded puller rod between the nut and plate when removing bearings.

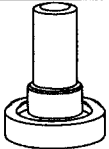

Pinion Gear Locating Tool	91-12349A05
 <p>3608</p>	Measures pinion gear height.

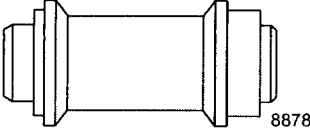
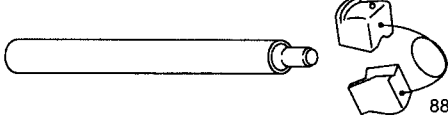
Mandrel	91-13658T
 <p>13513</p>	Aids in the installation of bushings, bearings and races into the gearcase.

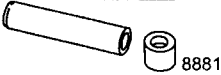
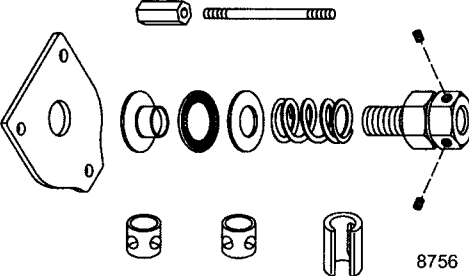
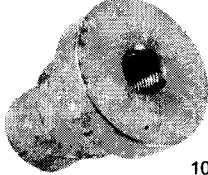
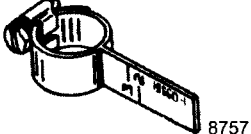
Bearing Installation Driver	91-13945
 <p>8877</p>	Installs reverse gear needle bearing into prop shaft carrier.

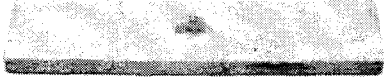
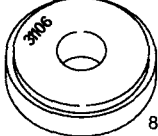
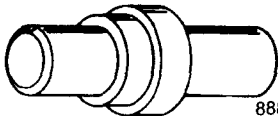
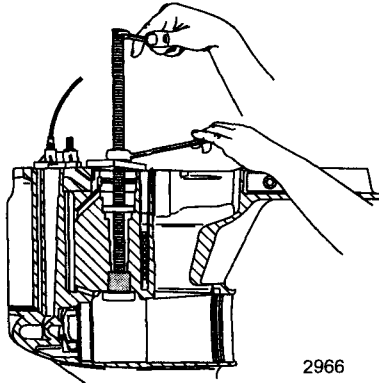

Section 2 - FourStroke Models

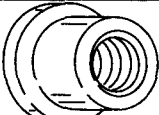
<p>Oil Seal Driver</p>  <p>8878</p>	<p>91-13949</p> <p>Installs oil seals into water pump base.</p>
<p>Bearing Race Driver</p>  <p>8879</p>	<p>91-14308T02</p> <p>Removes pinion bearing race.</p>
<p>Bearing Installation Puller</p>  <p>8880</p>	<p>91-14309T02</p> <p>Installs pinion bearing into gearcase.</p>
<p>Wear Sleeve Driver</p>  <p>8881</p>	<p>91-14310T 1</p> <p>Installs wear sleeve onto driveshaft.</p>
<p>Bearing Preload Tool</p>  <p>8756</p>	<p>91-14311A04</p> <p>Simulates a load on the driveshaft for accurate pinion height and backlash measurements.</p>
<p>Needle Bearing Driver</p>  <p>10787</p>	<p>91-15755T</p> <p>Installs needle bearings into bearing carriers.</p>
<p>Backlash Indicator</p>  <p>8757</p>	<p>91-19660--1</p> <p>Measures gear backlash.</p>
<p>Puller</p>  <p>8760</p>	<p>91-27780</p> <p>Removes gears, bearings and races.</p>

<p>Puller Plate</p>	<p>91-29310</p>
 <p>18600</p>	<p>Aids in the removal and installation of the gimbal bearing, as well as various bearings in the gear housing. Also included in the Bearing Removal and Installation Kit (91-31229A 7).</p>
<p>Bearing Cup Driver</p>	<p>91-31106T</p>
 <p>8882</p>	<p>Installs the driven gear bearing cup.</p>
<p>Oil Seal Driver</p>	<p>91-31108T</p>
 <p>8883</p>	<p>Installs bearing carrier oil seals.</p>
<p>Bearing Removal and Installation Kit</p>	<p>91-31229A7</p>
 <p>2966</p>	<p>Installs and removes the bearings in all gearcases. 91-31229A7 tool assembly includes the following components: 11-24156 Hex Nut 12-34961 Washer 91-15755T Bearing Carrier 91-29310 Plate 91-29610 Pilot Plate 91-30366T1 Mandrel 91-31229 Puller Shaft 91-32325T Driver Head 91-32336 Driver Needle Bearing 91-36379 Puller/Head Gear 91-36569T Driver Head 91-36571T Pilot Washer 91-37292 Roller Bearing 91-37311 Driver Head 91-37312 -Driver Head 91-37323 Driver Head Rod 91-37324 Pilot Washer 91-38628T Puller/Driver Head 91-52393 Driver Needle Bearing 91-52394 Head Pull Rod</p>
<p>Slide Hammer</p>	<p>91-34569A 1</p>
 <p>6761</p>	<p>Aids in the removal of various engine components. Use with puller jaws.</p>
<p>Driver Head</p>	<p>91-36569T</p>
 <p>ob01634</p>	<p>Used in pinion gear and bearing installation.</p>

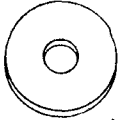
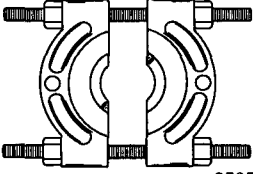
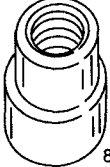
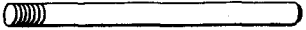
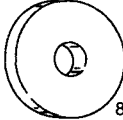
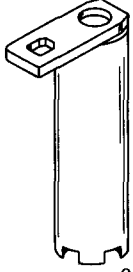
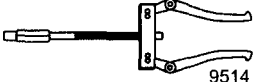
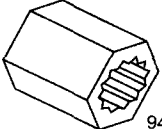

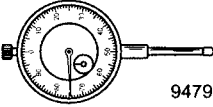
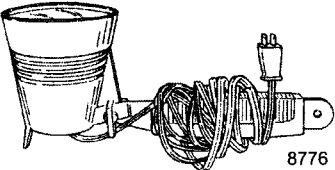
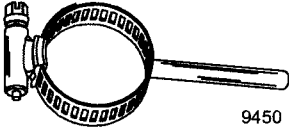
Section 2 - FourStroke Models

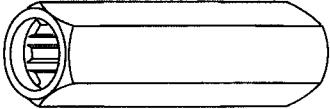
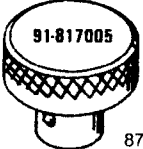
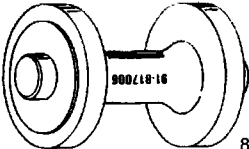
<p>Pilot Washer</p>  <p>ob01619</p>	<p>91-36571T</p> <p>Used in pinion gear and pinion bearing installation.</p>
<p>Universal Puller Plate</p>  <p>8505</p>	<p>91-37241</p> <p>Removes bearings from gears and the driveshaft.</p>
<p>Driveshaft Bearing Driver Head</p>  <p>8762</p>	<p>91-37312T</p> <p>Removes bearings from gears and bearing carrier.</p>
<p>Driver Rod</p>  <p>25431</p>	<p>91-37323</p> <p>Used in pinion gear and pinion bearing installation.</p>
<p>Pilot Mandrel</p>  <p>8884</p>	<p>91-37350T</p> <p>Presses on inner race of forward gear roller bearing.</p>
<p>Driveshaft Bearing Retainer Wrench</p>  <p>9520</p>	<p>91-43506T</p> <p>Removes and installs the threaded bearing retainer.</p>
<p>Puller Jaws Assembly</p>  <p>9514</p>	<p>91-46086A1</p> <p>Removes bearing carrier and bearing races; use with Puller Bolt (91-85716).</p>
<p>Driveshaft Holding Tool</p>  <p>9448</p>	<p>91-56775T</p> <p>Provides a wrench surface to turn the driveshaft. Also used to hold driveshaft for pinion gear installation.</p>



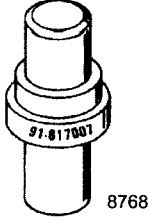
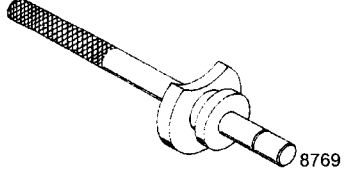
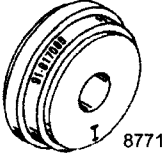
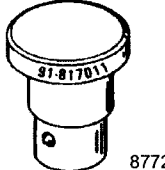
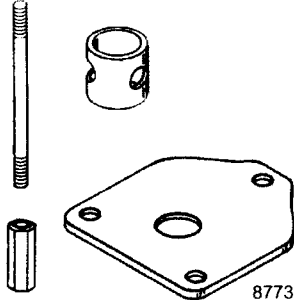

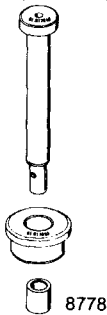
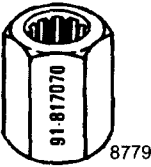
Dial Indicator	91-58222A1
 <p>9479</p>	Used to obtain a variety of measurements including gear backlash, pinion gear location, and TDC.
Torch Lamp	91-63209
 <p>8776</p>	Heats surfaces to aid in the removal and installation of interference fit engine components.
Backlash Indicator Rod	91-78473
 <p>9450</p>	Aids in checking gear backlash.
Backlash Indicator Arm	91-803133 12
 <p>12512</p>	Aids in determining the forward gear backlash; use with a dial indicator.
Driveshaft Holding Tool	91-804762
 <p>12519</p>	Holds the driveshaft while removing or installing the pinion gear nut.
Driveshaft Holding Tool	91-804776A1
 <p>12376</p>	Holds driveshaft while removing or torquing the pinion nut.
Forward Gear Bearing Installer	91-817005
 <p>8763</p>	Aids in the installation of the forward gear needle bearing.
Water Pump Base Seal Installer	91-817006
 <p>8767</p>	Installs upper and lower water pump base seals.

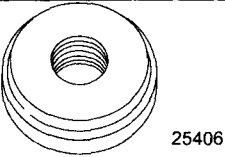
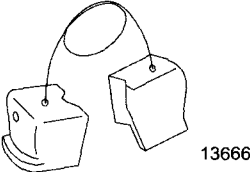
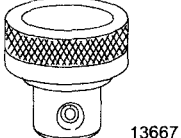

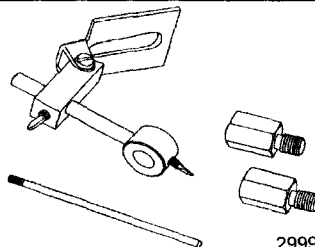
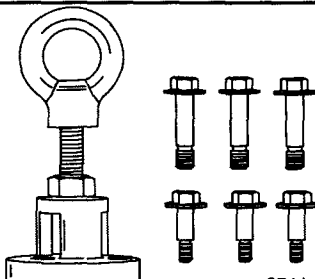
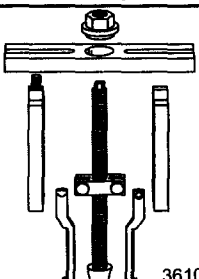
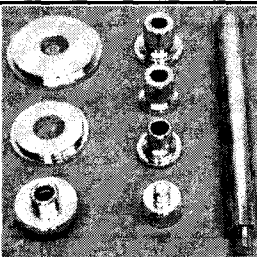

Section 2 - FourStroke Models

<p>Bearing Carrier Seal Installer</p>	<p>91-817007T</p>
 <p>8768</p>	<p>Installs upper and lower bearing carrier seals.</p>
<p>Pinion Gear Location Tool</p>	<p>91-817008A 2</p>
 <p>8769</p>	<p>Checks gearcase pinion gear height.</p>
<p>Forward Gear Bearing Race Driver Cup</p>	<p>91-817009T</p>
 <p>8771</p>	<p>Aids in the installation of forward gear bearing race.</p>
<p>Needle Bearing Installer</p>	<p>91-817011T</p>
 <p>8772</p>	<p>Installs needle bearing in the bearing carrier.</p>
<p>Bearing Preload Tool Update Kit</p>	<p>91-817057A02</p>
 <p>8773</p>	<p>Use to update Bearing Preload Tool (91-14311A1).</p>

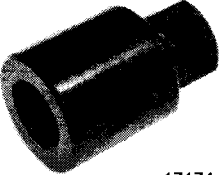
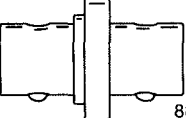
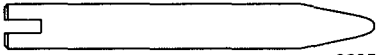

<p>Lower Driveshaft Bearing Driver Assembly</p>	<p>91-817058A 1</p>
	<p>Removes and installs lower driveshaft bearing.</p>
<p>Driveshaft Holding Tool</p>	<p>91-817070</p>
	<p>Holds driveshaft while removing pinion nut.</p>
<p>Seal/Bushing Installer</p>	<p>91-824785T 1</p>
	<p>Aids in the installation of the bushing into the bearing carrier.</p>
<p>Mandrel</p>	<p>91-825198</p>
	<p>Aids in the installation of the bearing carrier oil seals.</p>
<p>Spring Hook</p>	<p>91-825200A 1</p>
	<p>Aids in the removal of the pinion bearing race from the gearcase; use with driver (91-13779).</p>
<p>Driver</p>	<p>91-826872</p>
	<p>Aids in the installation of the propeller shaft needle bearing into the forward gear.</p>

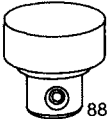
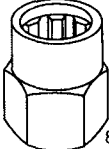

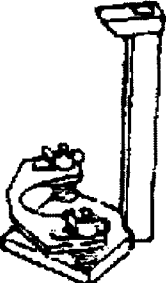
Section 2 - FourStroke Models

<p>Dial Indicator Adapter</p>  <p>2999</p>	<p>91-83155</p> <p>Attaches the dial indicator to the gearcase when checking backlash.</p>
<p>Flywheel Puller/Lifting Ring</p>  <p>8744</p>	<p>91-83164M</p> <p>Removes flywheel from engine. Used for lifting powerhead/engine.</p>
<p>Bearing Puller Assembly</p>  <p>3610</p>	<p>91-83165T</p> <p>Removes bearings, races and bearing carriers</p>
<p>Bearing Mandrel Kit</p>  <p>3421</p>	<p>91-83166M</p> <p>Aids in the removal and installation of bearings and bearing races.</p>
<p>Spring Pin Removal Tool</p>  <p>3423</p>	<p>91-853996-6</p> <p>Aids in the removal of the spring pins.</p>
<p>Spring Pin Driver</p>  <p>3422</p>	<p>91-853996 8</p> <p>Aids in the installation of the shift cam spring pin.</p>
<p>Pinion Nut Tool</p>  <p>17189</p>	<p>91-853996 12</p> <p>Removes the pinion nut; aids in the installation of the driveshaft bearing.</p>

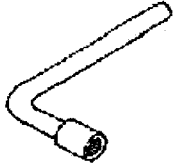
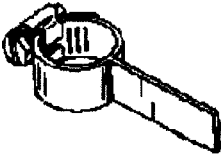
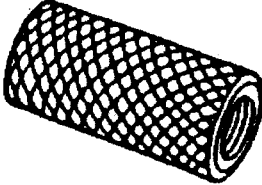
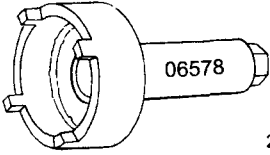
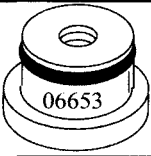

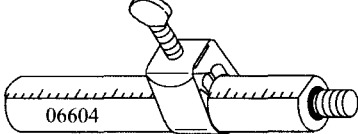
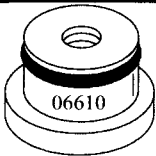

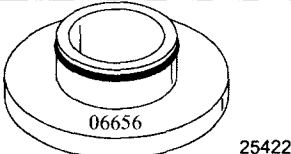
Driveshaft Holding Tool	91-853996 14
 <p>17174</p>	Holds the driveshaft while removing or installing the pinion gear nut.
Bearing Driver	91-856875A 1
 <p>8885</p>	Installs prop shaft needle bearing into 3 jaw or 6 jaw forward gear.
Slotted Cross Pin Tool	91-86642--1
 <p>9895</p>	Assists in clutch assembly/disassembly.
Driveshaft Bushing Installation Tool	91-875215A1
 <p>12359</p>	Installs the driveshaft bushing.
Bearing Driver	91-877321A 1
 <p>8886</p>	Installs prop shaft needle bearing into 6 jaw forward gear.
Driveshaft Holding Tool	91-877840A 1
 <p>8780</p>	Holds driveshaft while removing pinion nut.
Driver Rod (stamped 06605)	91-888870
 <p>06605 25409</p>	Aids in the removal and installation of bearings; used with various mandrels.
Pinion Height Gauge	91-888875T
 <p>25410</p>	Measures the gear housing length when installing pinion gear shims.

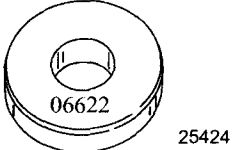
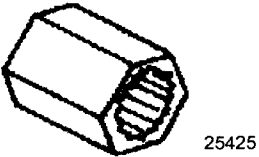
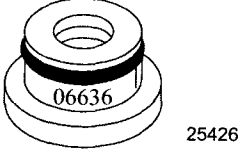
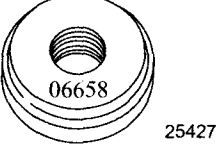
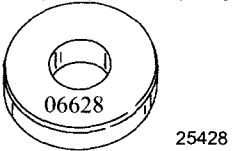

Section 2 - FourStroke Models

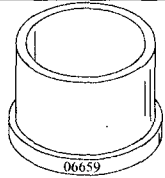
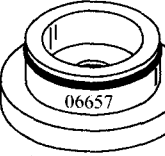
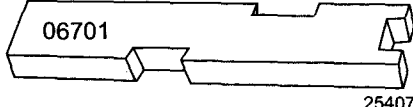
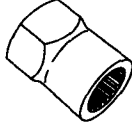
<p>Shift Rod</p>  <p>25411</p>	<p>91-888877</p> <p>Aids in shifting the gearcase while performing various service procedures.</p>
<p>Backlash Indicator Tool</p>  <p>25408</p>	<p>91-888878</p> <p>Aids in checking gear backlash.</p>
<p>Propeller Shaft Adapter (stamped 06514)</p>  <p>25441</p>	<p>91-888879</p> <p>Attaches to the propeller shaft for use with a slide hammer.</p>
<p>Spanner Wrench (stamped 06578)</p>  <p>25443</p>	<p>91-888880T</p> <p>Removes and installs the bearing carrier retainer nut.</p>
<p>Mandrel (stamped 06653)</p>  <p>25414</p>	<p>91-888881</p> <p>Aids in the removal of the bearing carrier oil seals. Also used to install bearings into the reverse gear assembly.</p>
<p>Driver Rod (stamped 06652)</p>  <p>25418</p>	<p>91-888882</p> <p>Aids in the removal and installation of bearings; used with various mandrels.</p>
<p>Driver Rod with Stop (stamped 06604)</p>  <p>25419</p>	<p>91-888883</p> <p>Aids in setting the bearing depth; used with a mandrel.</p>
<p>Mandrel (stamped 06610)</p>  <p>25420</p>	<p>91-888884</p> <p>Aids in the removal and installation of various bearings and oil seals in the bearing carrier.</p>

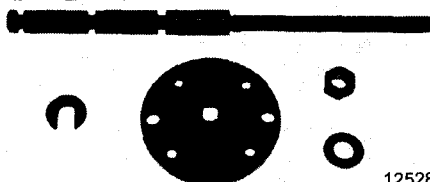
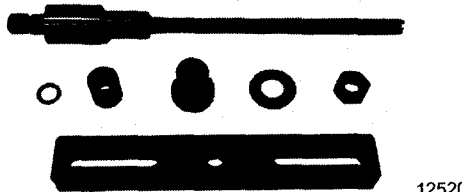
<p>Bearing Depth Plate (stamped 06603)</p> 	<p>91-888885</p> <p>Shimming gauge for reverse gear assembly.</p>
<p>Mandrel (stamped 06656)</p> 	<p>91-888886</p> <p>Aids in the installation of the propeller shaft bearings into the bearing carrier.</p>
<p>Driver Rod (stamped 06606)</p> 	<p>91-888887</p> <p>Aids in the removal and installation of bearings; used with various mandrels.</p>
<p>Mandrel (stamped 06622)</p> 	<p>91-888888</p> <p>Aids in the installation of the reverse gear into the bearing carrier.</p>
<p>Driveshaft Holding Tool</p> 	<p>91-888889</p> <p>Provides a wrench surface to rotate the driveshaft. Also used to hold the driveshaft for pinion gear installation.</p>
<p>Mandrel (stamped 06636)</p> 	<p>91-888890</p> <p>Aids in the removal of the driveshaft needle bearings in the gearcase.</p>
<p>Mandrel (stamped 06658)</p> 	<p>91-888891</p> <p>Aids in the installation of the reverse gear bearing.</p>
<p>Mandrel (stamped 06628)</p> 	<p>91-888892</p> <p>Aids in the installation of bearings and oil seals into the bearing carrier and gearcase.</p>

Section 2 - FourStroke Models

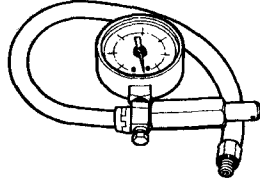
<p>Mandrel (stamped 06659)</p>  <p>25429</p>	<p>91-888893</p> <p>Aids in the installation of the tapered roller bearing onto the forward gear.</p>
<p>Mandrel (stamped 06657)</p>  <p>25444</p>	<p>91-888894</p> <p>Aids in the removal and installation of various bearings and seals.</p>
<p>Shimming Plate (stamped 06701)</p>  <p>25407</p>	<p>91-889586</p> <p>Fixture used to shim the forward gear.</p>
<p>Driveshaft Holding Tool</p>  <p>ob01206</p>	<p>91-889958T</p> <p>Holds driveshaft during pinion nut removal on the Verado models.</p>
<p>Pinion Bearing Tool</p>  <p>3777</p>	<p>91-895195</p> <p>Guides the removal and installation of the pinion bearing.</p>
<p>Bearing Installation Tool</p>  <p>12528</p>	<p>91-895195001</p> <p>Aids in the installation of bearings into the gearcase.</p>
<p>Backlash Preload Tool</p>  <p>12520</p>	<p>91-895195004</p> <p>Prevents forward gear movement when checking the forward gear backlash.</p>
<p>Pinion Height Tool</p>  <p>17369</p>	<p>91-895218</p> <p>Aids in determining the pinion gear height.</p>

Leakage Tester Kit	FT8950
 <p>ob01632</p>	<p>Checks gear housing for leakage prior to filling with gear lubricant. Also used to pressurize the oil injection system.</p>
Expanding Rod	Snap-On CG40-4
 <p>12538</p>	<p>Aids in the removal of gears and bearings; use with collet.</p>
Collet	Snap-On CG40A-6
 <p>12534</p>	<p>Aids in the removal of gears or bearings; use with expanding rod.</p>

Notes:

Section 3 - OptiMax Models

Table of Contents

Installation and Maintenance.....	76	Powerhead.....	82
Maintenance Tool Application Chart.....	76	Powerhead Tool Application Chart.....	82
Maintenance Tools.....	76	Powerhead Tools.....	83
Electrical and Ignition.....	77	Mid-Section.....	85
Electrical Tool Application Chart.....	77	Mid-Section Tool Application Chart.....	85
Electrical Tools.....	77	Mid-Section Tools.....	86
Fuel System.....	79	Lower Unit.....	87
Fuel System Tool Application Chart.....	79	Gear Housing Tool Application Chart.....	87
Fuel System Tools.....	80	Gear Housing Tools.....	90

3

Installation and Maintenance

Maintenance Tool Application Chart

Part No.	Description	75/90/115 OptiMax DFI	115/135/150/175 OptiMax DFI	200 OptiMax Jet Drive	200/225 OptiMax DFI	225/250 Pro XS OptiMax
44357Q2	Flushing Device	X	X		X	X
881150K1	Dual Water Pick-Up Flush Gearcase Seal Kit				X	X
91-37299Q2	Grease Gun	X	X	X	X	X
91-90455-1	Lifting Eye	X			X	X
91-98234A2	Transom Drilling Fixture		X			X

Maintenance Tools

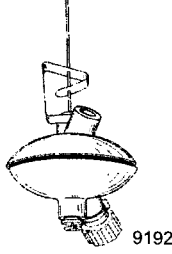
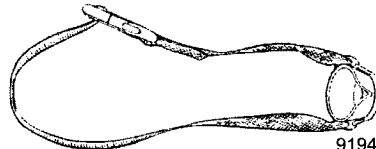
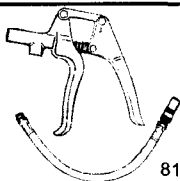
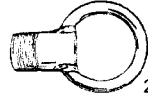
<p>Flushing Device</p>  <p>9192</p>	<p>44357Q 2</p> <p>Attaches to the water intakes; provides a fresh water connection when flushing the cooling system or operating the engine.</p>
<p>Dual Water Pick-up Flush Gearcase Seal Kit</p>  <p>9194</p>	<p>881150K 1</p> <p>Blocks off the front water inlet holes on the dual water inlet gearcases.</p>
<p>Grease Gun</p>  <p>8120</p>	<p>91-37299Q 2</p> <p>Aids in the lubrication of key areas on the engine. Allows easy access to grease fittings.</p>
<p>Lifting Eye</p>  <p>2756</p>	<p>91-90455--1</p> <p>Threads into the flywheel to remove the powerhead assembly from the driveshaft housing, or to lift entire engine for removal/installation.</p>

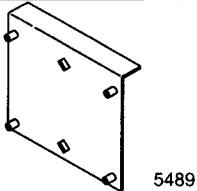
Transom Drilling Fixture	91-98234A2
	Aids in engine installation by acting as a template for engine mounting holes.

Electrical and Ignition



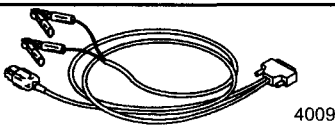
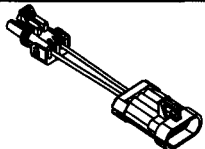

Electrical Tool Application Chart

Part No.	Description	75/90/115 OptiMax DFI	115/135/150/175 OptiMax DFI	200 OptiMax Jet Drive	200/225 OptiMax DFI	225/250 Pro XS OptiMax
84-822560A5	Adapter Harness	X	X	X	X	X
84-822560T12	2 to 4 Pin Harness Adapter	X	X		X	X
84-825003A1	Extension Cable	X	X	X	X	X
91-24161	Protector Cap	X	X	X	X	
91-52344	Flywheel Holding Tool	X	X	X	X	X
91-802650 1	Clamp-on Current Probe	X	X	X	X	X
91-849154T1	Flywheel Puller	X	X	X	X	X
91-850439T1	Spark Gap Tester	X	X	X	X	
91-892647A01	DMT 2004 Digital Multimeter	X	X	X	X	X
91-99379	Timing Light	X	X	X	X	
91-99750A1	DVA/Multimeter Kit	X	X	X	X	
Order Through SPX	Computer Diagnostic System (CDS)	X	X	X	X	X

Electrical Tools

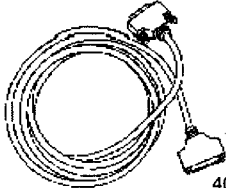
Adapter Harness	84-822560A5
	Data link harness between engine and Computer Diagnostic System (CDS) or Digital Diagnostic Terminal (DDT) on engines with a 2 pin diagnostic connection.
2 to 4 Pin Harness Adapter	84-822560T12
	Adapts the 2 pin Digital Diagnostic Terminal harness to the 4 pin connector on the engine.

Section 3 - OptiMax Models

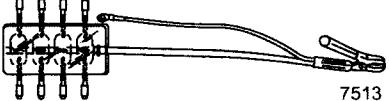
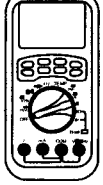
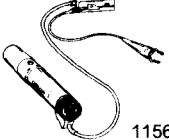
Extension Cable	84-825003A1
 <p>4012</p>	Data link extension harness (3.05 m[10 ft.]) between adapter harness and Digital Diagnostic Terminal
Protector Cap	91-24161
 <p>13445</p>	Protects the crankshaft when removing the flywheel; use with flywheel puller (91-849154T 1)
Flywheel Holding Tool	91-52344
 <p>4738</p>	Holds and/or turns the flywheel while making engine repairs, also used to torque the flywheel or the engine coupler.
Clamp-on Current Probe	91-802650-1
 <p>4006</p>	Measures the current output of battery charging systems or current draw of electric motors.
Flywheel Puller	91-849154T 1
 <p>7617</p>	Removes the flywheel from the crankshaft.
Spark Gap Tester	91-850439T 1
 <p>7513</p>	Provides a visual indication of spark/coil efficiency.
DMT 2004 Digital Multimeter	91-892647A01
 <p>4516</p>	Measures RPM on spark ignition (SI) engines, ohms, amperes, AC and DC voltages; records maximums and minimums simultaneously, and accurately reads in high RFI environments.
Timing Light	91-99379
 <p>11561</p>	Allows a technician to check ignition timing.

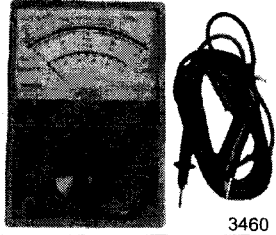
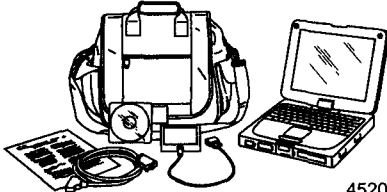
DVA/Multimeter Kit	91-99750A 1
 <p>3460</p>	<p>Tests the electrical and ignition systems; consists of a VOA meter with built-in direct voltage adapter.</p>
Computer Diagnostic System (CDS)	Order through SPX
 <p>4520</p>	<p>Monitors all electrical systems for proper function, diagnostics, and calibration purposes. For additional information, pricing, or to order the Computer Diagnostic System contact: SPX Corporation 28635 Mound Rd. Warren, MI 48092 or call: USA - 1-800-345-2233 Canada - 800-345-2233 Europe - 49 6182 959 149 Australia - (03) 9544-6222</p>

Fuel System



Fuel System Tool Application Chart

Part No.	Description	75/90/115 OptiMax DFI	115/135/150/175 OptiMax DFI	200 OptiMax Jet Drive	200/225 OptiMax DFI	225/250 Pro XS OptiMax
22-849606	Schrader Valve Tree	X	X	X	X	X
91-803146A04	Hose Clamp Tool Kit	X	X	X	X	X
91-804063	Tubing Clamp	X	X	X	X	X
91-851980-2	Seal/Teflon Ring Sizing Tool	X	X	X	X	X
91-851980-3	Seal/Teflon Ring Installation Tool	X	X	X	X	X
91-881833A03	Fuel Pressure Gauge Kit	X	X	X	X	
91-881834A1	Duel Fuel/Air Pressure Gauge Kit	X	X	X	X	X
91-883521	Direct Injector Removal Tool	X	X	X	X	X
91-889431	Air Regulator Installation Tool	X		X	X	X
91-892647A01	DMT 2004 Digital Multimeter	X	X	X	X	X
91-892651A01	Digital Pressure Meter	X	X	X	X	X
91-99750A1	DVA/Multimeter Kit	X	X	X	X	

Section 3 - OptiMax Models

Part No.	Description	75/90/115 OptiMax DFI	115/135/150/175 OptiMax DFI	200 OptiMax Jet Drive	200/225 OptiMax DFI	225/250 Pro XS OptiMax
FT8950	Leakage Tester Kit	X	X	X	X	X
Order through SPX	Computer Diagnostic System (CDS)	X	X	X	X	X

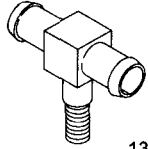
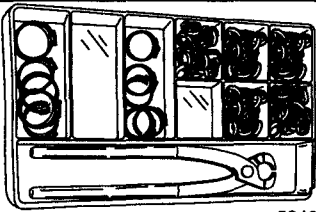
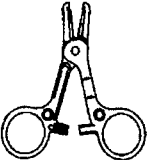
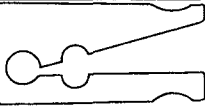
Fuel System Tools

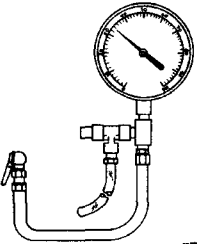
<p>Schrader Valve Tee</p>  <p>13678</p>	<p>22-849606</p> <p>Aids in checking fuel pressure when using a fuel pressure gauge with a screw on schrader valve connector.</p>
<p>Hose Clamp Tool Kit</p>  <p>5819</p>	<p>91-803146A04</p> <p>Aids in the installation of high pressure (Oetiker ®) hose clamps.</p>
<p>Tubing Clamp</p>  <p>13688</p>	<p>91-804063</p> <p>Compresses a fuel or vacuum hose for troubleshooting the fuel system or synchronizing a multiple carburetor engine.</p>
<p>Seal/Teflon Ring Sizing Tool</p>  <p>8286</p>	<p>91-851980--2</p> <p>Compresses the Teflon seal on direct injectors after seal installation.</p>
<p>Seal/Teflon Ring Installation Tool</p>  <p>8285</p>	<p>91-851980--3</p> <p>Aids in the installation of Teflon seals on direct injectors.</p>
<p>Fuel Pressure Gauge Kit</p>  <p>rms32</p>	<p>91-881833A03</p> <p>Tests the fuel pump pressure; can be used to relieve fuel pressure.</p>

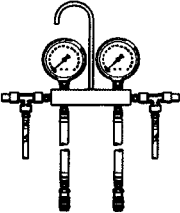
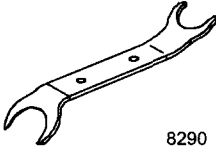
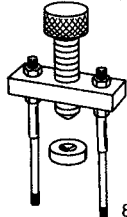
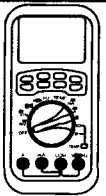
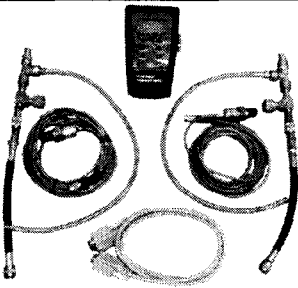
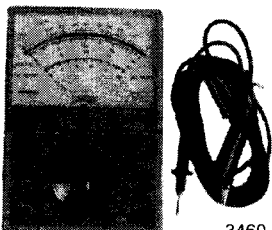
Dual Fuel/Air Pressure Gauge Kit	91-881834A 1
 <p>5822</p>	<p>Tests fuel and air pressure; the dual gauges allow the viewing of both pressures simultaneously.</p>
Direct Injector Removal Tool	91-883521
 <p>8290</p>	<p>Aids in the removal of direct injectors from the fuel rail.</p>
Air Regulator Installation Tool	91-889431
 <p>8291</p>	<p>Compresses the air regulator spring to allow installation of assembly screws.</p>
DMT 2004 Digital Multimeter	91-892647A01
 <p>4516</p>	<p>Measures RPM on spark ignition (SI) engines, ohms, amperes, AC and DC voltages; records maximums and minimums simultaneously, and accurately reads in high RFI environments.</p>
Digital Pressure Meter	91-892651A01
 <p>5786</p>	<p>Connects to the fuel system/manifold and can be used in conjunction with Computer Diagnostic System (CDS).</p>
DVA/Multimeter Kit	91-99750A 1
 <p>3460</p>	<p>Tests the electrical and ignition systems; consists of a VOA meter with built-in direct voltage adapter.</p>

Section 3 - OptiMax Models

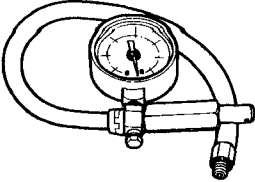
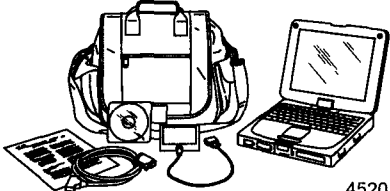
Leakage Tester Kit	FT8950
 <p style="text-align: right;">ob01632</p>	<p>Checks gear housing for leakage prior to filling with gear lubricant. Also used to pressurize the oil injection system.</p>
Computer Diagnostic System (CDS)	Order through SPX
 <p style="text-align: right;">4520</p>	<p>Monitors all electrical systems for proper function, diagnostics, and calibration purposes. For additional information, pricing, or to order the Computer Diagnostic System contact: SPX Corporation 28635 Mound Rd. Warren, MI 48092 or call: USA - 1-800-345-2233 Canada - 800-345-2233 Europe - 49 6182 959 149 Australia - (03) 9544-6222</p>





Powerhead

Powerhead Tool Application Chart

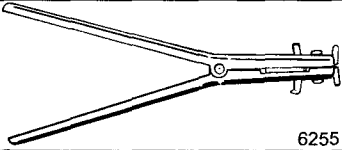
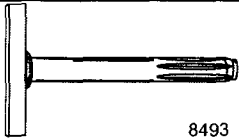
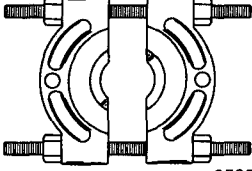

Part No.	Description	75/90/115 OptiMax DFI	115/135/150/175 OptiMax DFI	200 OptiMax Jet Drive	200/225 OptiMax DFI	225/250 Pro XS OptiMax
91-24161	Protector Cap				X	
91-24697	Piston Ring Expander	X	X	X	X	X
91-30591T1	Powerhead Stand		X	X	X	X
91-37241	Universal Puller Plate	X	X	X	X	X
91-52024A1	Remote Starter Switch	X	X	X	X	X
91-52344	Flywheel Holding Tool	X	X	X	X	X
91-52952T1	Lockring Removal Tool	X	X	X	X	X
91-74607A3	Piston Pin Tool		X	X		
91-77109A3	Lockring Installation Tool		X	X		
91-79250A2	Water Pressure Gauge	X	X	X	X	X
91-812549T	Powerhead Stand	X				
91-818773T	Piston Ring Compressor		X	X		
91-823237T	Piston Ring Compressor	X			X	X
91-849154T1	Flywheel Puller	X	X	X	X	X
91-883521	Direct Injector Removal Tool	X				
91-90455-1	Lifting Eye	X	X	X	X	X

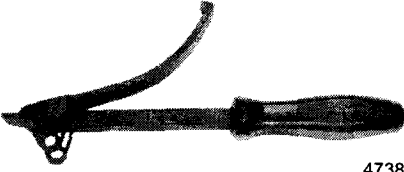

Part No.	Description	75/90/115 OptiMax DFI	115/135/150/175 OptiMax DFI	200 OptiMax Jet Drive	200/225 OptiMax DFI	225/250 Pro XS OptiMax
91-92973A1	Piston Pin Tool	X	X		X	X
91-93004A2	Lockring Installation Tool	X			X	X
Snap-On EEPV303B	Compression Tester with Adapter	X			X	X

Powerhead Tools

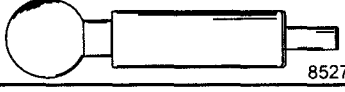
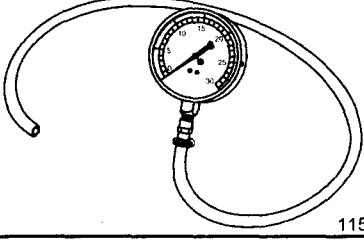
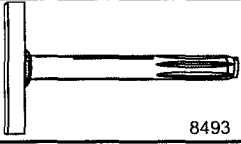
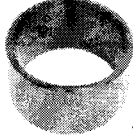
Protector Cap  13445	91-24161 Protects the crankshaft when removing the flywheel; use with flywheel puller (91-849154T 1)
Piston Ring Expander  6255	91-24697 Expands piston rings for removal and installation.
Powerhead Stand  8493	91-30591T 1 Used to secure and rotate the powerhead during disassembly and assembly.
Universal Puller Plate  8505	91-37241 Removes bearings from gears and the driveshaft.
Remote Starter Switch  10882	91-52024A1 Provides a remote starter button to crank the engine when performing service procedures.
Flywheel Holding Tool  4738	91-52344 Holds and/or turns the flywheel while making engine repairs, also used to torque the flywheel or the engine coupler.
Lockring Removal Tool  8500	91-52952T 1 Removes the lockrings securing the piston wrist pin.

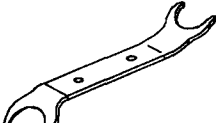
Section 3 - OptiMax Models

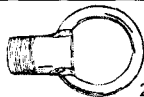
<p>Piston Pin Tool</p>  <p>20637</p>	<p>91-74607A3</p> <p>Aids in the removal and installation of the piston wrist pin.</p>
<p>Lockring Installation Tool</p>  <p>8527</p>	<p>91-77109A3</p> <p>Installs the lockrings to secure the piston wrist pin in piston.</p>
<p>Water Pressure Gauge</p>  <p>11598</p>	<p>91-79250A 2</p> <p>Aids in checking the engine water pressure.</p>
<p>Powerhead Stand</p>  <p>8493</p>	<p>91-812549T</p> <p>Used to secure and rotate the powerhead during disassembly and assembly.</p>
<p>Piston Ring Compressor</p>  <p>4739</p>	<p>91-818773T</p> <p>Compresses piston rings into piston ring grooves to ease piston rod assembly into cylinder block.</p>
<p>Piston Ring Compressor</p>  <p>4739</p>	<p>91-823237T</p> <p>Compresses piston rings into piston ring grooves to ease piston rod assembly into cylinder block.</p>
<p>Flywheel Puller</p>  <p>7617</p>	<p>91-849154T 1</p> <p>Removes the flywheel from the crankshaft.</p>
<p>Direct Injector Removal Tool</p>  <p>8290</p>	<p>91-883521</p> <p>Aids in the removal of direct injectors from the fuel rail.</p>

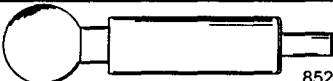
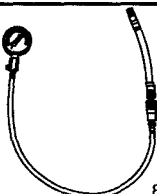



Lifting Eye  2756	91-90455--1 Threads into the flywheel to remove the powerhead assembly from the driveshaft housing, or to lift entire engine for removal/installation.
Piston Pin Tool  11564	91-92973A 1 Aids in the removal and installation of the piston pins.
Lockring Installation Tool  8527	91-93004A 2 Installs the lockrings to secure the piston wrist pin in piston.
Compression Tester with Adapter  8511	Snap-On EEPV303B Checks cylinder compression. Use with M14 x 1.25 adapter.



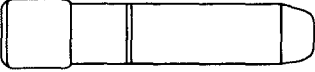
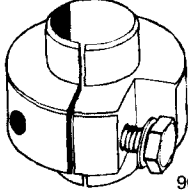

Mid-Section

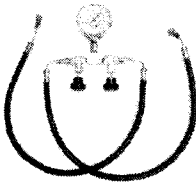
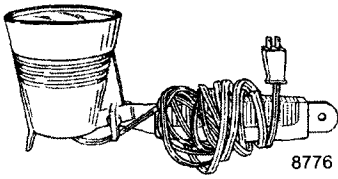
Mid-Section Tool Application Chart

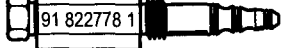
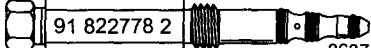
Part No.	Description	75/90/115 OptiMax DFI	115/135/150/175 OptiMax DFI	200/225 OptiMax DFI	225/250 Pro XS OptiMax
91-11230-1	Alignment Tool		X	X	X
91-44486A1	Trim Rod Removal Tool		X	X	X
91-44487T1	Trim Rod Guide Removal Tool		X	X	X
91-52915A6	Power Trim Test Gauge Kit	X	X	X	X
91-63209	Torch Lamp	X	X	X	X
91-74951	Spanner Wrench	X	X	X	X
91-822778A1	Adapter Fitting	X			
91-822778A2	Adapter Fitting		X	X	X
91-822778A3	Adapter Fitting	X	X	X	X
91-875215	Driveshaft Bushing Installer Tool	X			
91-892647A01	DMT 2004 Digital Multimeter				X
91-99750A1	DVA/Multimeter Tester	X	X	X	
Snap-On CG41-11	Expanding Rod	X			
Snap-On CG41-12	Collet	X			
Snap-On SRP-4	Lock Ring Pliers	X	X	X	

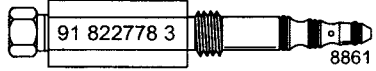
Mid-Section Tools

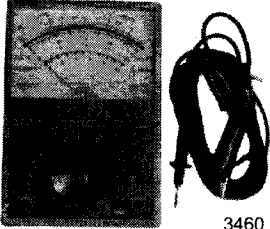
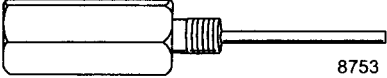
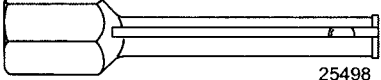
Alignment Tool	91-11230--1
 <p>9078</p>	Aligns the tilt ram with housing to aid installation of the pivot pin.
Trim Rod Removal Tool	91-44486A 1
 <p>9089</p>	Aids in the removal of the trim rod from the trim cylinders.
Trim Rod Guide Removal Tool	91-44487T 1
 <p>9086</p>	Aids in the removal of the trim rod from the trim cylinders.
Power Trim Test Gauge Kit	91-52915A6
 <p>3753</p>	Tests circuit pressures for various trim pumps.
Torch Lamp	91-63209
 <p>8776</p>	Heats surfaces to aid in the removal and installation of interference fit engine components.
Spanner Wrench	91-74951
 <p>8775</p>	Removes and installs trim cylinder end caps.
Adapter Fitting	91-822778A 1
 <p>91 822778 1 12203</p>	Measures the internal pressure in the up mode for a single cylinder trim system.
Adapter Fitting	91-822778A 2
 <p>91 822778 2 8637</p>	Install in place of the manual release valve to measure the internal pressure of the power trim pump in the up mode.

Adapter Fitting	91-822778A 3
	Install in place of the manual release valve to measure the internal pressure of the power trim pump in the down mode.
Driveshaft Bushing Installer Tool	91-875215
	Aids in the installation of driveshaft bushings.
DMT 2004 Digital Multimeter	91-892647A01
	Measures RPM on spark ignition (SI) engines, ohms, amperes, AC and DC voltages; records maximums and minimums simultaneously, and accurately reads in high RFI environments.
DVA/Multimeter Kit	91-99750A 1
	Tests the electrical and ignition systems; consists of a VOA meter with built-in direct voltage adapter.
Expanding Rod	Snap-On CG41-11
	Aids in the removal of the spool from the power trim pump.
Collet	Snap-On CG41-12
	Aids in the removal of internal components in the power trim valve; use with an expanding rod.
Lock-Ring Pliers	Snap-On SRP-4
	Aids in the removal of lock rings.

Lower Unit

Gear Housing Tool Application Chart

Part Number	Description	75/90/115 OptiMax	115/135/150/175 OptiMax	200 OptiMax Jet Drive	200/225 OptiMax	225/250 Pro XS OptiMax
12-34961	Washer					X
12-37429	Load Washer		X		X	
12-54048	Belleville Washer				X	

Section 3 - OptiMax Models

Part Number	Description	75/90/115 OptiMax	115/135/150/175 OptiMax	200 OptiMax Jet Drive	200/225 OptiMax	225/250 Pro XS OptiMax
44-93003	Propeller Shaft Tool		X		X	
91-12349A05	Pinion Gear Locating Tool	X	X		X	X
91-13945	Bearing Installation Driver	X				
91-13949	Oil Seal Driver	X				
91-14308T02	Bearing Race Driver	X				
91-14309T02	Bearing Installation Puller	X				
91-14310T1	Wear Sleeve Driver	X				
91-14311A04	Bearing Preload Tool	X	X		X	X
91-15755T	Needle Bearing Driver	X	X		X	
91-18605A2	Bearing Cup/ Adapter Installation Tool		X		X	X
91-19660-1	Backlash Indicator	X				
91-31106T	Bearing Cup Driver	X	X		X	
91-31107T	Shift Shaft Bushing Tool		X			
91-31108T	Oil Seal Driver	X	X		X	
91-31229A7	Bearing Removal and Installation Kit	X	X		X	X
91-33491	Needle Bearing Driver					X
91-34569A1	Slide Hammer	X	X	X	X	X
91-36569T	Driver Head	X			X	X
91-36571T	Pilot Washer		X		X	X
91-37241	Universal Puller Plate	X	X		X	X
91-37323	Driver Rod	X	X		X	X
91-37350T	Pilot Mandrel	X				
91-38628T	Puller/Driver Head		X		X	X
91-43506T	Driveshaft Bearing Retainer Wrench		X		X	X
91-46086A1	Puller Jaws Assembly	X	X		X	X
91-53459	Backlash Indicator Rod			X	X	X
91-56775T	Driveshaft Holding Tool	X			X	X
91-58222A1	Dial Indicator	X	X	X	X	X
91-61067A04	Pinion Nut Wrench				X	X

Section 3 - OptiMax Models

Part Number	Description	75/90/115 OptiMax	115/135/150/175 OptiMax	200 OptiMax Jet Drive	200/225 OptiMax	225/250 Pro XS OptiMax
91-61069T	Bearing Carrier Retainer Nut Wrench		X		X	
91-61077T	Propeller Shaft/ Driveshaft Adapter				X	
91-66274	Torque Wrench,lb.in				X	
91-74776T	Pinion Height Tool		X			
91-78473	Backlash Indicator Rod	X	X		X	
91-809957A1	Jet Pump Tool Kit			X		
91-815850	Forward Gear Assembly Tube		X		X	
91-816242	Puller Jaws				X	
91-816243	Guide Plate				X	
91-816244	Reverse Gear Needle Bearing Driver				X	
91-816245	Needle Bearing Removal Tool				X	
91-816292	Needle Bearing Driver					X
91-817569T	Carrier Seal Driver				X	X
91-821571A1	Water Pump Alignment Pins				X	X
91-83155	Dial Indicator Adapter	X		X	X	X
91-83165T	Bearing Puller Assembly			X		
91-840388	Bearing Carrier Installation Tool					X
91-840393	Bearing Carrier Retainer Nut Wrench					X
91-856875A1	Bearing Driver	X				
91-86642	Cross Pin Tool		X			
91-86642-2	Cross Pin (T-Handle) Installation Tool					X
91-86943T	Guide Plate		X		X	
91-87120T	Bearing Cup Driver					X
91-877321A1	Bearing Driver	X			X	
91-89897	Dial Indicator Holding Tool		X		X	
91-90094	Driveshaft Holding Tool		X			
91-92788T	Pinion Bearing Driver		X		X	

Section 3 - OptiMax Models



Part Number	Description	75/90/115 OptiMax	115/135/150/175 OptiMax	200 OptiMax Jet Drive	200/225 OptiMax	225/250 Pro XS OptiMax
FT8950	Leakage Tester Kit				X	X

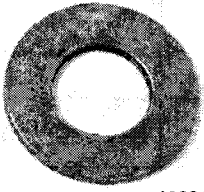
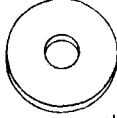
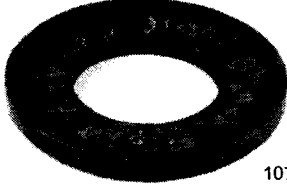
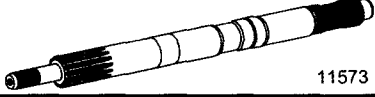
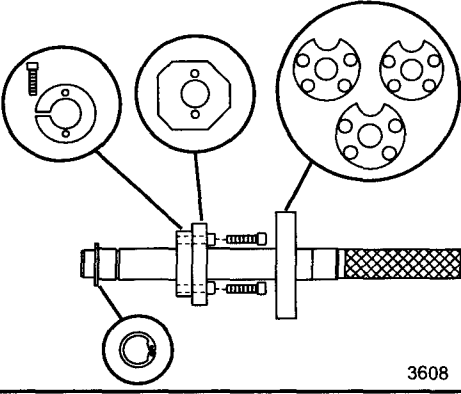
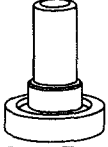

Gear Housing Tools

<p>Washer</p>  <p>10834</p>	<p>12-34961</p> <p>Use on the threaded puller rod between the nut and plate when removing bearings.</p>
<p>Load Washer</p>  <p>ob01619</p>	<p>12-37429</p> <p>Creates a load on the forward gear when taking forward gear backlash measurements for counter rotation gearcases.</p>
<p>Belleville Washer</p>  <p>10772</p>	<p>12-54048</p> <p>Use with the Pinion Nut Adaptor (91-61067A3) and a propeller nut to check the reverse gear backlash.</p>
<p>Propeller Shaft Tool</p>  <p>11573</p>	<p>44-93003</p> <p>Acts as a dummy propeller shaft when taking forward gear backlash measurements for counter rotation gearcases.</p>
<p>Pinion Gear Locating Tool</p>  <p>3608</p>	<p>91-12349A05</p> <p>Measures pinion gear height.</p>
<p>Bearing Installation Driver</p>  <p>8877</p>	<p>91-13945</p> <p>Installs reverse gear needle bearing into prop shaft carrier.</p>

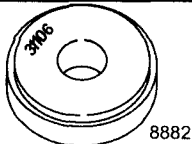
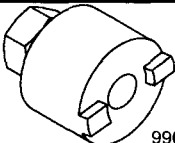
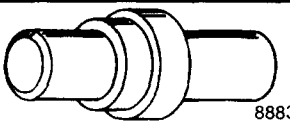
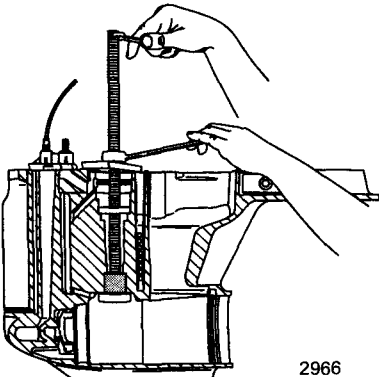

Oil Seal Driver	91-13949
<p>8878</p>	Installs oil seals into water pump base.
Bearing Race Driver	91-14308T02
<p>8879</p>	Removes pinion bearing race.
Bearing Installation Puller	91-14309T02
<p>8880</p>	Installs pinion bearing into gearcase.
Wear Sleeve Driver	91-14310T 1
<p>8881</p>	Installs wear sleeve onto driveshaft.
Bearing Preload Tool	91-14311A04
<p>8756</p>	Simulates a load on the driveshaft for accurate pinion height and backlash measurements.
Needle Bearing Driver	91-15755T
<p>10787</p>	Installs needle bearings into bearing carriers.
Bearing Cup/Adapter Installation Tool	91-18605A 2
<p>9591</p>	Installs the forward gear bearing race on a standard gearcase. Presses the reverse gear bearing adapter into the gear housing on a counter rotating gearcase.
Backlash Indicator	91-19660-1
<p>8757</p>	Measures gear backlash.

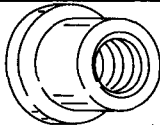
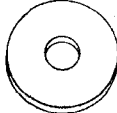
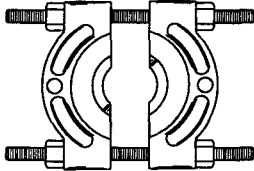
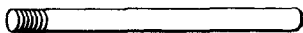
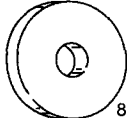

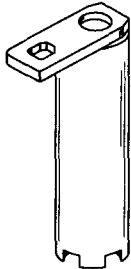
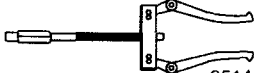
Section 3 - OptiMax Models

<p>Bearing Cup Driver</p>  <p>8882</p>	<p>91-31106T</p> <p>Installs the driven gear bearing cup.</p>
<p>Shift Shaft Bushing Tool</p>  <p>9906</p>	<p>91-31107T</p> <p>Aids in the removal and installation of the shift shaft bushing.</p>
<p>Oil Seal Driver</p>  <p>8883</p>	<p>91-31108T</p> <p>Installs bearing carrier oil seals.</p>
<p>Bearing Removal and Installation Kit</p>  <p>2966</p>	<p>91-31229A7</p> <p>Installs and removes the bearings in all gearcases.</p> <p>91-31229A7 tool assembly includes the following components:</p> <ul style="list-style-type: none"> 11-24156 Hex Nut 12-34961 Washer 91-15755T Bearing Carrier 91-29310 Plate 91-29610 Pilot Plate 91-30366T1 Mandrel 91-31229 Puller Shaft 91-32325T Driver Head 91-32336 Driver Needle Bearing 91-36379 Puller/Head Gear 91-36569T Driver Head 91-36571T Pilot Washer 91-37292 Roller Bearing 91-37311 Driver Head 91-37312 -Driver Head 91-37323 Driver Head Rod 91-37324 Pilot Washer 91-38628T Puller/Driver Head 91-52393 Driver Needle Bearing 91-52394 Head Pull Rod
<p>Needle Bearing Driver</p>  <p>9443</p>	<p>91-33491</p> <p>Installs the needle bearing in the forward gear. Removes and installs the seals and bearing in the gimbal housing.</p>
<p>Slide Hammer</p>  <p>6761</p>	<p>91-34569A 1</p> <p>Aids in the removal of various engine components. Use with puller jaws.</p>

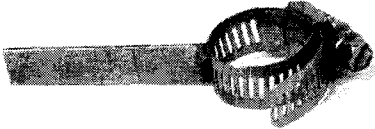
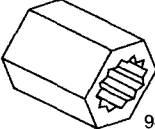
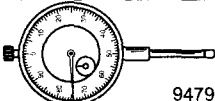
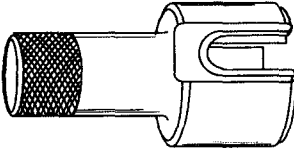
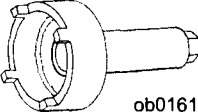

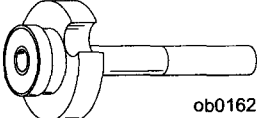
Driver Head	91-36569T
 <p>ob01634</p>	Used in pinion gear and bearing installation.
Pilot Washer	91-36571T
 <p>ob01619</p>	Used in pinion gear and pinion bearing installation.
Universal Puller Plate	91-37241
 <p>8505</p>	Removes bearings from gears and the driveshaft.
Driver Rod	91-37323
 <p>25431</p>	Used in pinion gear and pinion bearing installation.
Pilot Mandrel	91-37350T
 <p>8884</p>	Presses on inner race of forward gear roller bearing.
Puller/Driver Head	91-38628T
 <p>ob01622</p>	Used in pinion gear and pinion bearing installation.
Driveshaft Bearing Retainer Wrench	91-43506T
 <p>9520</p>	Removes and installs the threaded bearing retainer.
Puller Jaws Assembly	91-46086A1
 <p>9514</p>	Removes bearing carrier and bearing races; use with Puller Bolt (91-85716).

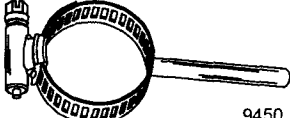
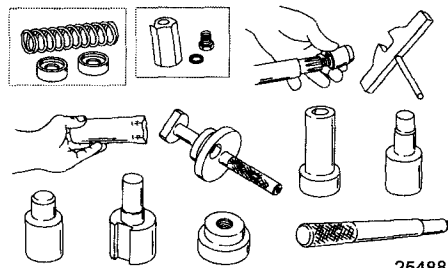
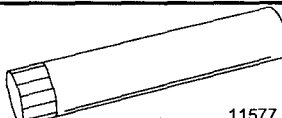
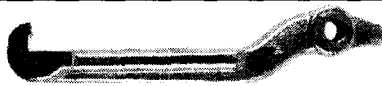
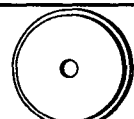

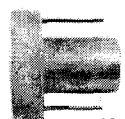

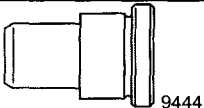
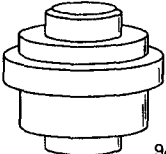

Section 3 - OptiMax Models

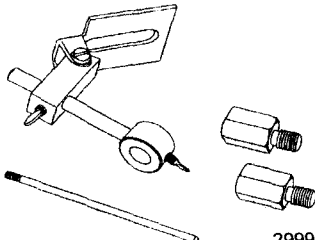
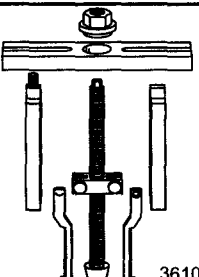
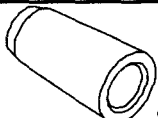
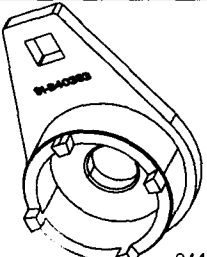
<p>Backlash Indicator Rod</p>  <p>10452</p>	<p>91-53459</p> <p>Aids in checking gear backlash.</p>
<p>Driveshaft Holding Tool</p>  <p>9448</p>	<p>91-56775T</p> <p>Provides a wrench surface to turn the driveshaft. Also used to hold driveshaft for pinion gear installation.</p>
<p>Dial Indicator</p>  <p>9479</p>	<p>91-58222A1</p> <p>Used to obtain a variety of measurements including gear backlash, pinion gear location, and TDC.</p>
<p>Pinion Nut Wrench</p>  <p>9593</p>	<p>91-61067A04</p> <p>Holds the pinion nut when removing the pinion gear and driveshaft. Also, use with Belleville washer and propeller nut to check the reverse gear lash.</p>
<p>Bearing Carrier Retainer Nut Wrench</p>  <p>ob01615</p>	<p>91-61069T</p> <p>Installs and removes the bearing carrier retainer nuts.</p>
<p>Propeller Shaft/Driveshaft Adapter</p>  <p>10805</p>	<p>91-61077T</p> <p>Provides a wrench surface to turn the propeller shaft or the driveshaft.</p>
<p>Torque Wrench, lb. in.</p>  <p>10829</p>	<p>91-66274</p> <p>Dial type torque wrench that sets torque from 9 to 150 lb. in.; 3/8 in. drive.</p>
<p>Pinion Height Tool</p>  <p>ob01627</p>	<p>91-74776T</p> <p>Checks pinion gear height.</p>

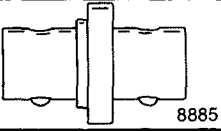
<p>Backlash Indicator Rod</p>  <p>9450</p>	<p>91-78473</p> <p>Aids in checking gear backlash.</p>
<p>Jet Pump Tool Kit</p>  <p>25488</p>	<p>91-809957A1</p> <p>Removes and install bearings and seals in the jet drive. Contains the following components: 91-824871A2 Preload Kit Impeller Shaft 91-824869A1 Thread Extender Kit 91-850233 Seal Protector Impeller Shaft 91-83203A1 Impeller Shaft Wrench 91-850297 Impeller Nut Socket 91-831897 Pinion Gear Location Tool 91-832016 Bearing Installer 91-850831 Bushing Installer 91-832019 Seal Installer 91-832017 Bearing Installer 91-832018 Bearing Cup Installer 91-824892 Driver Handle</p>
<p>Forward Gear Assembly Tube</p>  <p>11577</p>	<p>91-815850</p> <p>Removes and installs the forward gear/bearing adapter assembly for counter rotation gearcases.</p>
<p>Puller Jaws</p>  <p>10681</p>	<p>91-816242</p> <p>Use with either the two prong or three prong puller on all drive units.</p>
<p>Guide Plate</p>  <p>4481</p>	<p>91-816243</p> <p>Centers the rod used to drive in the forward gear bearing on a standard rotation gearcase, and the reverse gear bearing on a counter rotation gearcase.</p>
<p>Reverse Gear Needle Bearing Driver</p>  <p>10810</p>	<p>91-816244</p> <p>Installs the needle bearings into the reverse gear of a counter rotating gearcase.</p>
<p>Needle Bearing Removal Tool</p>  <p>10793</p>	<p>91-816245</p> <p>Removes the needle bearings from the back adaptor of a counter rotating gearcase.</p>

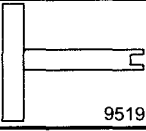
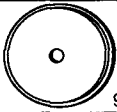
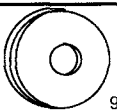
Section 3 - OptiMax Models

<p>Needle Bearing Driver</p>  <p>9444</p>	<p>91-816292</p> <p>Installs the needle bearing onto the forward gear.</p>
<p>Carrier Seal Driver</p>  <p>9481</p>	<p>91-817569T</p> <p>Removes and installs the bearing carrier seals. Installs seals in the driveshaft seal carrier.</p>
<p>Water Pump Alignment Pins</p>  <p>9482</p>	<p>91-821571A 1</p> <p>Aligns the water pump during installation.</p>
<p>Dial Indicator Adapter</p>  <p>2999</p>	<p>91-83155</p> <p>Attaches the dial indicator to the gearcase when checking backlash.</p>
<p>Bearing Puller Assembly</p>  <p>3610</p>	<p>91-83165T</p> <p>Removes bearings, races and bearing carriers</p>
<p>Bearing Carrier Installation Tool</p>  <p>9518</p>	<p>91-840388</p> <p>Installs the bearing carrier on heavy duty propeller shafts.</p>
<p>Bearing Carrier Retainer Nut Wrench</p>  <p>9449</p>	<p>91-840393</p> <p>Installs the bearing carrier retainer nut on heavy duty propeller shafts.</p>

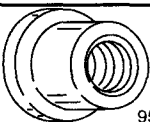
Bearing Driver	91-856875A 1
 <p>8885</p>	Installs prop shaft needle bearing into 3 jaw or 6 jaw forward gear.
Cross Pin Tool	91-86642
 <p>13539</p>	Aids in the installation of the cross pin into the clutch dog assembly.
Cross Pin (T-Handle) Installation Tool	91-86642--2
 <p>9519</p>	Assists in the assembly/disassembly of the clutch cross pin.
Guide Plate	91-86943T
 <p>9521</p>	Guides the forward gear bearing during installation.
Bearing Cup Driver	91-87120T
 <p>9445</p>	Installs the forward gear bearing cup.
Bearing Driver	91-877321A 1
 <p>8886</p>	Installs prop shaft needle bearing into 6 jaw forward gear.
Dial Indicator Holding Tool	91-89897
 <p>ob01631</p>	Secures the dial indicator to gear housing when checking backlash.
Driveshaft Holding Tool	91-90094
 <p>9882</p>	Assists in pinion gear installation.
Pinion Bearing Driver	91-92788T
 <p>9537</p>	Aids in the removal and installation of the pinion bearing.

Section 3 - OptiMax Models

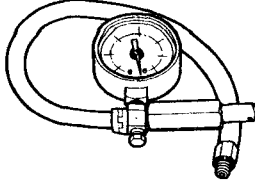
Leakage Tester Kit	FT8950
 <p>ob01632</p>	Checks gear housing for leakage prior to filling with gear lubricant. Also used to pressurize the oil injection system.

Section 4 - Verado Models

Table of Contents



Installation and Maintenance.....	100	Powerhead Tools.....	106
Maintenance Tool Application Chart.....	100	Mid-Section.....	108
Maintenance Tools.....	100	Mid-Section Tool Application Chart.....	108
Electrical and Ignition.....	102	Mid-Section Tools.....	108
Electrical Tool Application Chart.....	102	Lower Unit.....	110
Electrical Tools.....	102	Gear Housing Tool Application Chart.....	110
Fuel System.....	103	Gear Housing Tools.....	111
Fuel System Tool Application Chart.....	103	Power Steering.....	115
Fuel System Tools.....	103	Power Steering Tool Application Chart.....	115
Powerhead.....	105	Power Steering Tools.....	116
Powerhead Tool Application Chart.....	105		



Installation and Maintenance

Maintenance Tool Application Chart

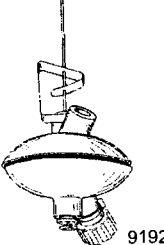
Part No.	Description	135/150/175 Verado 4-Stroke	200/225/250/275 Verado 4-Stroke
44357Q2	Flushing Device	X	X
881150K1	Dual Water Pick-up Flush Gearcase Seal Kit	X	X
888462A1	Data Cable Puller	X	X
91-889277Q03	Oil Filter Wrench	X	X
91-892866A01	Oil Drain Funnel		X
91-895343T02	Flywheel Puller/Lifting Ring	X	X
91-90265A5	Crankcase Oil Pump	X	X
91-98234A2	Transom Drilling Fixture	X	X
Snap-On EEPV303B	Compression Tester with Adapter	X	X
Snap-On EEPV309A	Cylinder Leakage Tester	X	X

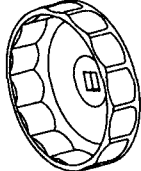
Maintenance Tools

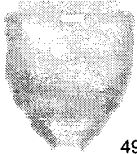
<p>Flushing Device</p>  <p>9192</p>	<p>44357Q 2</p> <p>Attaches to the water intakes; provides a fresh water connection when flushing the cooling system or operating the engine.</p>
<p>Dual Water Pick-up Flush Gearcase Seal Kit</p>  <p>9194</p>	<p>881150K 1</p> <p>Blocks off the front water inlet holes on the dual water inlet gearcases.</p>
<p>Data Cable Puller</p>  <p>4618</p>	<p>888462A1</p> <p>Attaches to end of DTS data harness to aid in pulling harness through boat. Prevents damage to DTS data harness.</p>
<p>Oil Filter Wrench</p>  <p>5221</p>	<p>91-889277Q03</p> <p>Assists in removal of oil filter.</p>

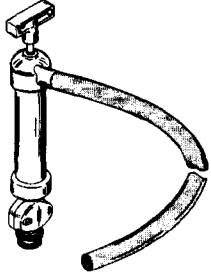
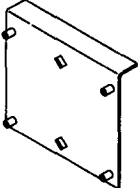
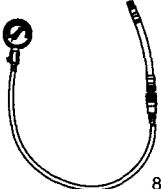
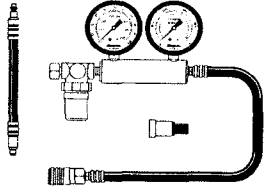
Oil Drain Funnel	91-892866A01
 <p>4993</p>	Diverts draining engine oil from contacting the anti-splash and anti-cavitation plates.
Flywheel Puller/Lifting Ring	91-895343T02
 <p>14869</p>	Removes flywheel from engine. Used for lifting powerhead/engine.
Crankcase Oil Pump	91-90265A 5
 <p>11591</p>	Aids in the removal of engine oil without draining the crankcase.
Transom Drilling Fixture	91-98234A2
 <p>5489</p>	Aids in engine installation by acting as a template for engine mounting holes.
Compression Tester with Adapter	Snap-On EEPV303B
 <p>8511</p>	Checks cylinder compression. Use with M14 x 1.25 adapter.
Cylinder Leakage Tester	Snap-On EEPV309A
 <p>11604</p>	Aids in checking cylinder leakdown.

Electrical and Ignition

Electrical Tool Application Chart

Part No.	Description	135/150/175 Verado 4-Stroke	200/225/250/275 Verado 4-Stroke
84-822560A13	Adapter Harness	X	X
84-825003A1	Extension Cable	X	X
91-52344	Flywheel Holding Tool	X	X
91-803146A04	Hose Clamp Tool Kit	X	X
91-892647A01	DMT 2004 Digital Multimeter	X	X
91-895343T02	Flywheel Puller/Lifting Ring	X	X
Order through SPX	Computer Diagnostic System	X	X

Electrical Tools

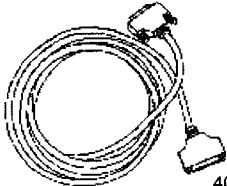
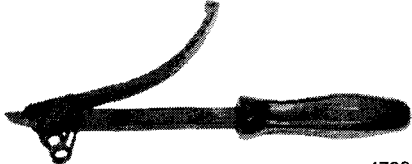
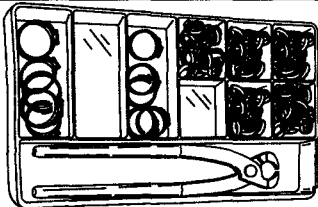
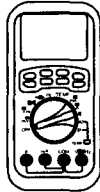
<p>Adapter Harness</p>  <p>5826</p>	<p>84-822560A13</p> <p>Data link harness between engine and Computer Diagnostic System (CDS) or Digital Diagnostic Terminal (DDT).</p>
<p>Extension Cable</p>  <p>4012</p>	<p>84-825003A1</p> <p>Data link extension harness (3.05 m[10 ft.]) between adapter harness and Digital Diagnostic Terminal</p>
<p>Flywheel Holding Tool</p>  <p>4738</p>	<p>91-52344</p> <p>Holds and/or turns the flywheel while making engine repairs, also used to torque the flywheel or the engine coupler.</p>
<p>Hose Clamp Tool Kit</p>  <p>5819</p>	<p>91-803146A04</p> <p>Aids in the installation of high pressure (Oetiker ®) hose clamps.</p>
<p>DMT 2004 Digital Multimeter</p>  <p>4516</p>	<p>91-892647A01</p> <p>Measures RPM on spark ignition (SI) engines, ohms, amperes, AC and DC voltages; records maximums and minimums simultaneously, and accurately reads in high RFI environments.</p>

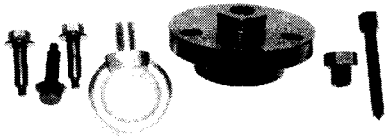
Flywheel Puller/Lifting Ring	91-895343T02
 <p>14869</p>	Removes flywheel from engine. Used for lifting powerhead/engine.

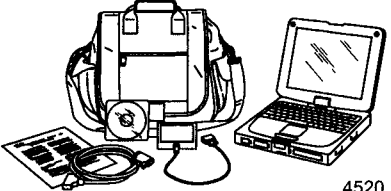
Computer Diagnostic System (CDS)	Order through SPX
 <p>4520</p>	Monitors all electrical systems for proper function, diagnostics, and calibration purposes. For additional information, pricing, or to order the Computer Diagnostic System contact: SPX Corporation 28635 Mound Rd. Warren, MI 48092 or call: USA - 1-800-345-2233 Canada - 800-345-2233 Europe - 49 6182 959 149 Australia - (03) 9544-6222

Fuel System

Fuel System Tool Application Chart

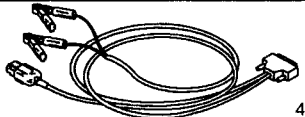

Part No.	Description	135/150/175 Verado 4-Stroke	200/225/250/275 Verado 4-Stroke
84-822560A5	Adapter Harness	X	X
84-822560A13	Adapter Harness	X	X
84-822560T12	2 to 4 Pin Harness Adapter	X	X
84-825003A1	Extension Cable	X	X
91-803146A04	Hose Clamp Tool Kit	X	X
91-881833A03	Fuel Pressure Gauge Kit	X	X
91-881834A1	Dual Fuel/Air Pressure Gauge Kit	X	X
91-892647A01	DMT 2004 Digital Multimeter	X	X
91-892651A01	Digital Pressure Meter	X	X
Order through SPX	Computer Diagnostic System (CDS)	X	X

Fuel System Tools

Adapter Harness	84-822560A5
 <p>4009</p>	Data link harness between engine and Computer Diagnostic System (CDS) or Digital Diagnostic Terminal (DDT) on engines with a 2 pin diagnostic connection.

Adapter Harness	84-822560A13
 <p>5826</p>	Data link harness between engine and Computer Diagnostic System (CDS) or Digital Diagnostic Terminal (DDT).

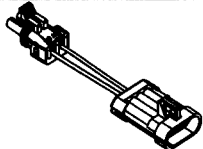
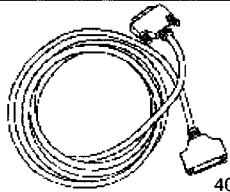
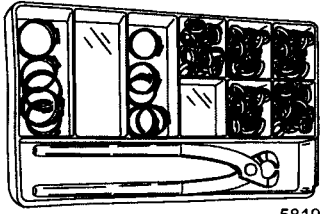
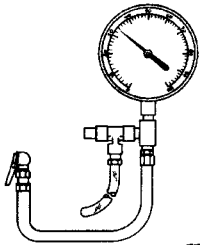
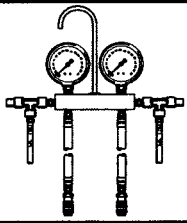
Section 4 - Verado Models

<p>2 to 4 Pin Harness Adapter</p>	<p>84-822560T12</p>
 <p>4679</p>	<p>Adapts the 2 pin Digital Diagnostic Terminal harness to the 4 pin connector on the engine.</p>
<p>Extension Cable</p>	<p>84-825003A1</p>
 <p>4012</p>	<p>Data link extension harness (3.05 m[10 ft.]) between adapter harness and Digital Diagnostic Terminal</p>
<p>Hose Clamp Tool Kit</p>	<p>91-803146A04</p>
 <p>5819</p>	<p>Aids in the installation of high pressure (Oetiker®) hose clamps.</p>
<p>Fuel Pressure Gauge Kit</p>	<p>91-881833A03</p>
 <p>rms32</p>	<p>Tests the fuel pump pressure; can be used to relieve fuel pressure.</p>
<p>Dual Fuel/Air Pressure Gauge Kit</p>	<p>91-881834A 1</p>
 <p>5822</p>	<p>Tests fuel and air pressure; the dual gauges allow the viewing of both pressures simultaneously.</p>
<p>DMT 2004 Digital Multimeter</p>	<p>91-892647A01</p>
 <p>4516</p>	<p>Measures RPM on spark ignition (SI) engines, ohms, amperes, AC and DC voltages; records maximums and minimums simultaneously, and accurately reads in high RFI environments.</p>

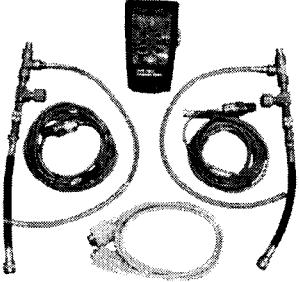
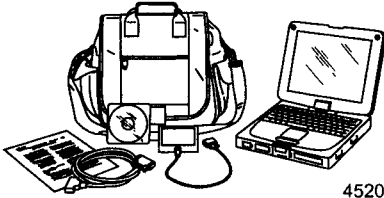



Digital Pressure Meter	91-892651A01
 <p style="text-align: right;">5786</p>	Connects to the fuel system/manifold and can be used in conjunction with Computer Diagnostic System (CDS).
Computer Diagnostic System (CDS)	Order through SPX
 <p style="text-align: right;">4520</p>	Monitors all electrical systems for proper function, diagnostics, and calibration purposes. For additional information, pricing, or to order the Computer Diagnostic System contact: SPX Corporation 28635 Mound Rd. Warren, MI 48092 or call: USA - 1-800-345-2233 Canada - 800-345-2233 Europe - 49 6182 959 149 Australia - (03) 9544-6222

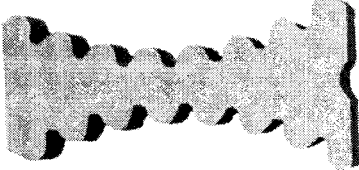

Powerhead

Powerhead Tool Application Chart

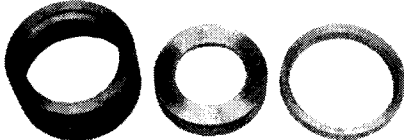
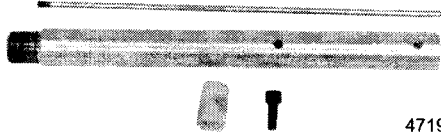

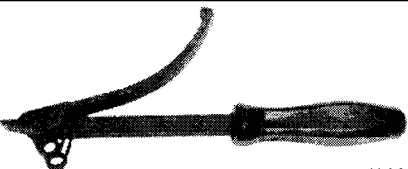
Part No.	Description	135/150/175 Verado 4-Stroke	200/225/250/275 Verado 4-Stroke
N/A	Cam Brake	X	X
N/A	Crankshaft Retainer	X	X
N/A	Crankshaft Seal Installation Tool	X	X
N/A	Dial Indicator Extension Adapter	X	X
N/A	Ring Compressor	X	X
N/A	Rod Guide Dowel	X	X
91-52344	Flywheel Holding Tool	X	X
91-58222A1	Dial Indicator	X	X
91-803146A04	Hose Clamp Tool Kit	X	X
91-809494A1	Valve Spring Compressor	X	X
91-809905001	13 mm Torque Adapter	X	X
91-881833A03	Fuel Pressure Gauge Kit	X	X
91-881834A1	Dual Fuel/Air Pressure Gauge Kit	X	X
91-892651A01	Digital Pressure Meter	X	X
91-895343T02	Flywheel Puller/Lifting Ring	X	X

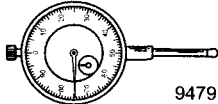
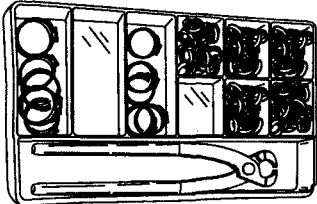
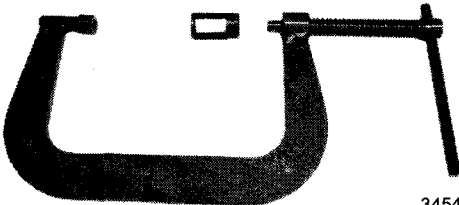
Powerhead Tools

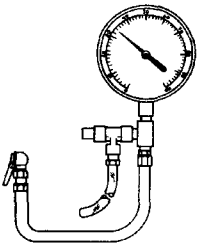
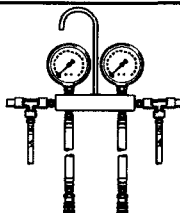
<p>Cam Brake</p>	<p>Part number not available for this printing.</p>
 <p>5539</p>	<p>Prevents the intake and exhaust cam from turning while removing or installing cam retaining bolts.</p>
<p>Crankshaft Retainer</p>	<p>Part number not available for this printing.</p>
 <p>6191</p>	<p>Secures crankshaft to cylinder block while rotating block to install the cylinder head.</p>
<p>Crankshaft Seal Installation Tool</p>	<p>Part number not available for this printing</p>
 <p>15499</p>	<p>Aids in the installation of the crankshaft seal.</p>
<p>Dial Indicator Extension Adapter</p>	<p>Part number not available for this printing.</p>
 <p>4719</p>	<p>Extends the dial indicators reach.</p>
<p>Ring Compressor</p>	<p>Part number not available for this printing</p>
 <p>4739</p>	<p>Compresses piston rings when installing the piston into the cylinder block.</p>
<p>Rod Guide Dowel</p>	<p>Part number not available for this printing.</p>
 <p>4735</p>	<p>Prevents cylinder bore and crankshaft from damage while installing or removing connecting rod assembly.</p>
<p>Flywheel Holding Tool</p>	<p>91-52344</p>
 <p>4738</p>	<p>Holds and/or turns the flywheel while making engine repairs, also used to torque the flywheel or the engine coupler.</p>

Dial Indicator	91-58222A1
 <p>9479</p>	Used to obtain a variety of measurements including gear backlash, pinion gear location, and TDC.
Hose Clamp Tool Kit	91-803146A04
 <p>5819</p>	Aids in the installation of high pressure (Oetiker ®) hose clamps.
Valve Spring Compressor	91-809494A1
 <p>3454</p>	Removes and installs valve springs.
13 mm Torque Adapter	91-809905001
 <p>4631</p>	Aids in the removal and installation of powerhead nuts, and torquing nuts to specification.
Fuel Pressure Gauge Kit	91-881833A03
 <p>rms32</p>	Tests the fuel pump pressure; can be used to relieve fuel pressure.
Dual Fuel/Air Pressure Gauge Kit	91-881834A 1
 <p>5822</p>	Tests fuel and air pressure; the dual gauges allow the viewing of both pressures simultaneously.

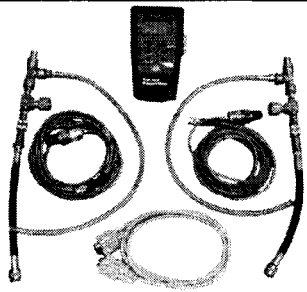
Section 4 - Verado Models



<p>Digital Pressure Meter</p>  <p>5786</p>	<p>91-892651A01</p> <p>Connects to the fuel system/manifold and can be used in conjunction with Computer Diagnostic System (CDS).</p>
<p>Flywheel Puller/Lifting Ring</p>  <p>14869</p>	<p>91-895343T02</p> <p>Removes flywheel from engine. Used for lifting powerhead/engine.</p>



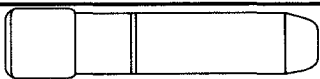

Mid-Section

Mid-Section Tool Application Chart

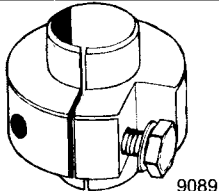

Part No.	Description	135/150/175 Verado 4-Stroke	200/225/250/275 Verado 4-Stroke
91-11230-1	Alignment Tool	X	
91-34569A1	Slide Hammer		X
91-44486A 1	Trim Rod Removal Tool	X	
91-44487T 1	Trim Rod Guide Removal Tool	X	
91-52915A6	Power Trim Test Gauge Kit	X	X
91-74951	Spanner Wrench	X	
91-821709T	Trim Cylinder End Cap Tool	X	X
91-822778A 2	Adapter Fitting	X	
91-822778A 3	Adapter Fitting	X	
91-822778004	Power Trim Adapter Fitting		X
91-87957T	Spanner Nut Socket	X	
91-892647A01	DMT 2004 Digital Multimeter	X	X
91-899015A01	Upper Mount Alignment Tool	X	
Snap-On SRP-4	Lock-Ring Pliers	X	
SPX P/N MM-46225	Breakout Box	X	X

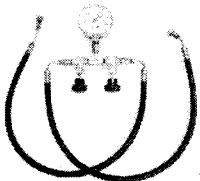
Mid-Section Tools

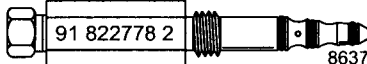
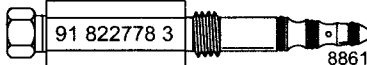
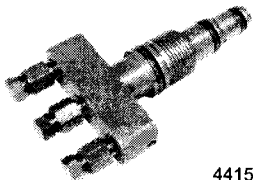
<p>Alignment Tool</p>  <p>9078</p>	<p>91-11230--1</p> <p>Aligns the tilt ram with housing to aid installation of the pivot pin.</p>
<p>Slide Hammer</p>  <p>6761</p>	<p>91-34569A 1</p> <p>Aids in the removal of various engine components. Use with puller jaws.</p>

Trim Rod Removal Tool	91-44486A 1
 <p>9089</p>	Aids in the removal of the trim rod from the trim cylinders.
Trim Rod Guide Removal Tool	91-44487T 1
 <p>9086</p>	Aids in the removal of the trim rod from the trim cylinders.
Power Trim Test Gauge Kit	91-52915A6
 <p>3753</p>	Tests circuit pressures for various trim pumps.
Spanner Wrench	91-74951
 <p>8775</p>	Removes and installs trim cylinder end caps.
Trim Cylinder End Cap Tool	91-821709T
 <p>10691</p>	Allows easy removal of the trim cylinder end caps. Required if tilt limit spacers are to be installed or if the trim in limit spacer is to be removed (to allow additional trim in range).
Adapter Fitting	91-822778A 2
 <p>91 822778 2 8637</p>	Install in place of the manual release valve to measure the internal pressure of the power trim pump in the up mode.
Adapter Fitting	91-822778A 3
 <p>91 822778 3 8861</p>	Install in place of the manual release valve to measure the internal pressure of the power trim pump in the down mode.
Power Trim Adapter Fitting	91-822778004
 <p>4415</p>	Replaces power trim manual release valve when testing power trim circuits.

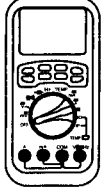
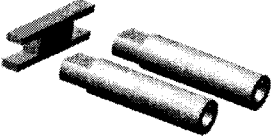
Section 4 - Verado Models

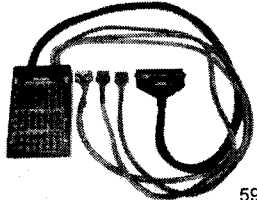
<p>Spanner Nut Socket</p>  <p>15638</p>	<p>91-87957T</p> <p>Aids in the removal and installation of the upper mount spanner nut.</p>
<p>DMT 2004 Digital Multimeter</p>  <p>4516</p>	<p>91-892647A01</p> <p>Measures RPM on spark ignition (SI) engines, ohms, amperes, AC and DC voltages; records maximums and minimums simultaneously, and accurately reads in high RFI environments.</p>
<p>Upper Mount Alignment Tool</p>  <p>15639</p>	<p>91-899015A01</p> <p>Aligns upper mount for assembly with the swivel pin assembly.</p>
<p>Lock-Ring Pliers</p>  <p>4799</p>	<p>Snap-On SRP-4</p> <p>Aids in the removal of lock rings.</p>
<p>Breakout Box</p>  <p>5974</p>	<p>SPX P/N MM-46225</p> <p>Connects to Propulsion Control Module (PCM) to test engine circuits and components without probing wires. May be used with Computer Diagnostic System (CDS).</p>

Lower Unit

Gear Housing Tool Application Chart



Part Number	Description	135/150/175 Verado 4-Stroke	200/225/250/275 Verado 4-Stroke
91-12349A05	Pinion Gear Locating Tool	X	X
91-31229A7	Bearing Removal and Installation Kit	X	X
91-34569A1	Slide Hammer	X	X
91-36569T	Driver Head	X	X
91-36571T	Pilot Washer	X	X
91-37241	Universal Puller Plate	X	X
91-37323	Driver Rod	X	X
91-38628T	Puller/Driver Head	X	X
91-43506T	Driveshaft Bearing Retainer Wrench	X	X

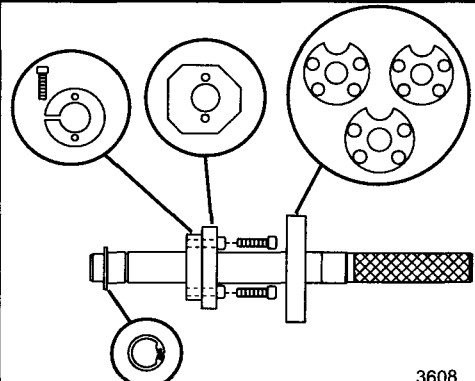

Part Number	Description	135/150/175 Verado 4-Stroke	200/225/250/275 Verado 4-Stroke
91-46086A1	Puller Jaws Assembly	X	X
91-56048001	Pinion Gear Locating Tool	X	X
91-58222A1	Dial Indicator	X	X
91-61067T03	Pinion Nut Wrench	X	X
91-61069T	Bearing Carrier Retainer Nut Wrench	X	X
91-61077T	Propeller Shaft/Driveshaft Adapter	X	X
91-78473	Backlash Indicator Rod	X	X
91-816243	Guide Plate	X	X
91-816245	Needle Bearing Removal Tool	X	
91-83155	Dial Indicator Adapter	X	X
91-83165T	Bearing Puller Assembly	X	X
91-885592T	Bearing Cup Driver	X	X
91-888414T	Bearing Cup Driver/Oil Seal Installer Tool	X	X
91-889844T	Oil Seal Driver	X	X
91-889845	Seal Driver Guide	X	X
91-889958T	Driveshaft Holding Tool	X	X
91-892866A01	Oil Drain Funnel		X
91-89897	Dial Indicator Holding Tool	X	X
FT8950	Leakage Tester Kit	X	X

Gear Housing Tools

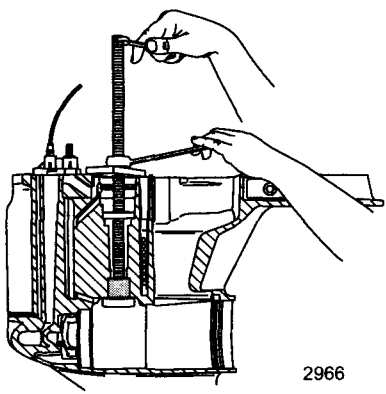
Pinion Gear Locating Tool	91-12349A05
 <p>3608</p>	<p>Measures pinion gear height.</p>

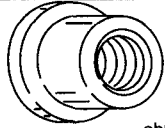
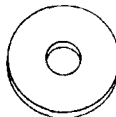
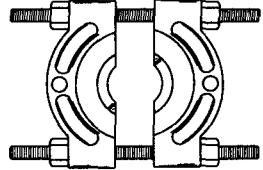
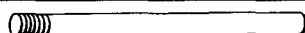

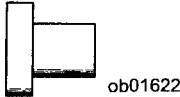
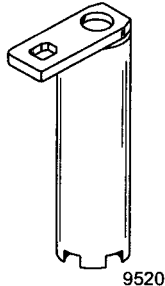
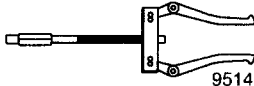
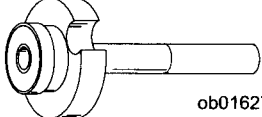
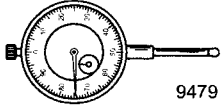
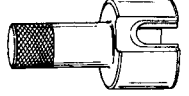
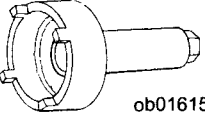
Section 4 - Verado Models

Bearing Removal and Installation Kit	91-31229A7
 <p>2966</p>	<p>Installs and removes the bearings in all gearcases. 91-31229A7 tool assembly includes the following components: 11-24156 Hex Nut 12-34961 Washer 91-15755T Bearing Carrier 91-29310 Plate 91-29610 Pilot Plate 91-30366T1 Mandrel 91-31229 Puller Shaft 91-32325T Driver Head 91-32336 Driver Needle Bearing 91-36379 Puller/Head Gear 91-36569T Driver Head 91-36571T Pilot Washer 91-37292 Roller Bearing 91-37311 Driver Head 91-37312 -Driver Head 91-37323 Driver Head Rod 91-37324 Pilot Washer 91-38628T Puller/Driver Head 91-52393 Driver Needle Bearing 91-52394 Head Pull Rod</p>
Slide Hammer	91-34569A 1
 <p>6761</p>	<p>Aids in the removal of various engine components. Use with puller jaws.</p>
Driver Head	91-36569T
 <p>ob01634</p>	<p>Used in pinion gear and bearing installation.</p>
Pilot Washer	91-36571T
 <p>ob01619</p>	<p>Used in pinion gear and pinion bearing installation.</p>
Universal Puller Plate	91-37241
 <p>8505</p>	<p>Removes bearings from gears and the driveshaft.</p>
Driver Rod	91-37323
 <p>25431</p>	<p>Used in pinion gear and pinion bearing installation.</p>

<p>Puller/Driver Head</p>  <p>ob01622</p>	<p>91-38628T</p> <p>Used in pinion gear and pinion bearing installation.</p>
<p>Driveshaft Bearing Retainer Wrench</p>  <p>9520</p>	<p>91-43506T</p> <p>Removes and installs the threaded bearing retainer.</p>
<p>Puller Jaws Assembly</p>  <p>9514</p>	<p>91-46086A1</p> <p>Removes bearing carrier and bearing races; use with Puller Bolt (91-85716).</p>
<p>Pinion Gear Locating Tool</p>  <p>ob01627</p>	<p>91-56048001</p> <p>Measures pinion gear height.</p>
<p>Dial Indicator</p>  <p>9479</p>	<p>91-58222A1</p> <p>Used to obtain a variety of measurements including gear backlash, pinion gear location, and TDC.</p>
<p>Pinion Nut Wrench</p>  <p>ob01639</p>	<p>91-61067T03</p> <p>Holds the pinion nut when removing the pinion gear and driveshaft.</p>
<p>Bearing Carrier Retainer Nut Wrench</p>  <p>ob01615</p>	<p>91-61069T</p> <p>Installs and removes the bearing carrier retainer nuts.</p>
<p>Propeller Shaft/Driveshaft Adapter</p>  <p>10805</p>	<p>91-61077T</p> <p>Provides a wrench surface to turn the propeller shaft or the driveshaft.</p>

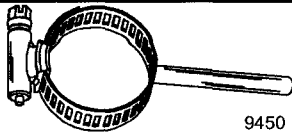
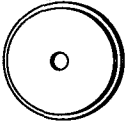
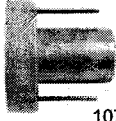
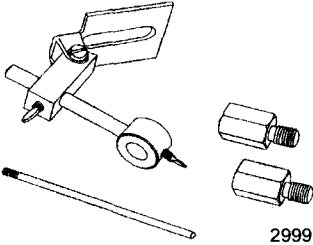
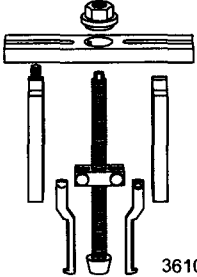
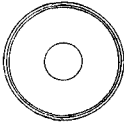
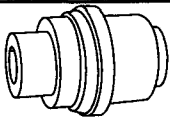
Section 4 - Verado Models

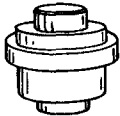
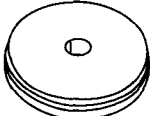
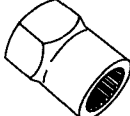
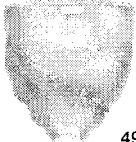
<p>Backlash Indicator Rod</p>  <p>9450</p>	<p>91-78473</p> <p>Aids in checking gear backlash.</p>
<p>Guide Plate</p>  <p>4481</p>	<p>91-816243</p> <p>Centers the rod used to drive in the forward gear bearing on a standard rotation gearcase, and the reverse gear bearing on a counter rotation gearcase.</p>
<p>Needle Bearing Removal Tool</p>  <p>10793</p>	<p>91-816245</p> <p>Removes the needle bearings from the back adaptor of a counter rotating gearcase.</p>
<p>Dial Indicator Adapter</p>  <p>2999</p>	<p>91-83155</p> <p>Attaches the dial indicator to the gearcase when checking backlash.</p>
<p>Bearing Puller Assembly</p>  <p>3610</p>	<p>91-83165T</p> <p>Removes bearings, races and bearing carriers</p>
<p>Bearing Cup Driver</p>  <p>ob01625</p>	<p>91-885592T</p> <p>Installs reverse gear bearing cup.</p>
<p>Bearing Cup Driver/Oil Seal Installer Tool</p>  <p>6229</p>	<p>91-888414T</p> <p>Installs bearing carrier cup and seals.</p>

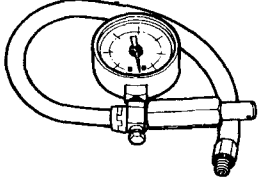
Oil Seal Driver	91-889844T
 ob01633	Installs seals in driveshaft seal carrier.
Seal Driver Guide	91-889845
 ob01670	Aids in the installation of bearing carrier seals.
Driveshaft Holding Tool	91-889958T
 ob01206	Holds driveshaft during pinion nut removal on the Verado models.
Oil Drain Funnel	91-892866A01
 4993	Diverts draining engine oil from contacting the anti-splash and anti-cavitation plates.
Dial Indicator Holding Tool	91-89897
 ob01631	Secures the dial indicator to gear housing when checking backlash.
Leakage Tester Kit	FT8950
 ob01632	Checks gear housing for leakage prior to filling with gear lubricant. Also used to pressurize the oil injection system.

Power Steering

Power Steering Tool Application Chart

Part No.	Description	135/150/175 Verado 4-Stroke	200/225/250/275 Verado 4-Stroke
N/A	Power Steering Cylinder End Cap Spanner Wrench		X
64-826525A 1	Steering Helm Fill Adapter	X	
91-895040K01	Power Steering Module Primer Kit	X	X

Power Steering Tools

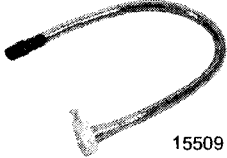
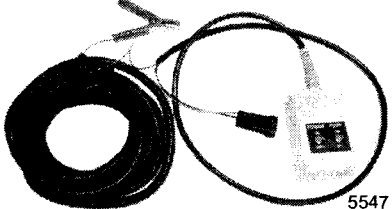
<p>Power Steering Cylinder End Cap Spanner Wrench</p>	<p>Part number not available for this printing.</p>
 <p>5080</p>	<p>Removes the power steering cylinder end cap.</p>
<p>Steering Helm Fill Adapter</p>	<p>64-826525A 1</p>
 <p>15509</p>	<p>Connects between the fluid bottle and helm to aid in filling the hydraulic steering helm.</p>
<p>Power Steering Module Primer Kit</p>	<p>91-895040K01</p>
 <p>5547</p>	<p>Bleeds power steering system without running engine.</p>

Section 5 - SmartCraft and Digital Throttle & Shift

Table of Contents

SmartCraft and Digital Throttle and Shift (DTS) Tool Application Chart.....	118	Computer Diagnostic System Adapter Cable Application Chart.....	121
Special Tools/Cables	118	Computer Diagnostic System Adapter Cables	122
SmartCraft and Digital Throttle and Shift Tools	119		

SmartCraft and Digital Throttle and Shift (DTS) Tool Application Chart



Special Tools/Cables

Part Number	Description	150-250 EFI 2-Stroke V-6	40-60 4-Stroke EFI	75 - 115 4-Stroke EFI (1.7 L)	75-115 OptiMax	135-175 OptiMax	200-225 OptiMax	200-225 OptiMax (DTS)	135-175 Verado	200-275 Verado
888462A1	Data Cable Puller	X	X	X	X	X	X	X	X	X
84-822560T12	2 to 4 Pin Harness Adapter			X					X	X
84-825003A1	Extension Cable	X	X	X	X	X	X	X	X	X
84-889243A01	Gauge Sweep Kit	X	X	X	X	X	X	X	X	X
84-892452A01	Male to Male 10 Pin Adapter							X	X	X
84-892663	CAN 1 Diagnostic Cable							X	X	X
91-803146A04	Hose Clamp Tool Kit			X	X	X	X	X	X	X
91-889675A01	12 Volt Connector Tool							X	X	X
91-892647A01	DMT 2004 Digital Multimeter	X	X	X	X	X	X	X	X	X
91-892651A01	Digital Pressure Meter	X	X	X	X	X	X	X	X	X
91-896352	De-pinning Tool	X	X	X	X	X	X	X	X	X
91-898254	Command Module MX Breakout Box							X	X	X
Order through SPX	Computer Diagnostic System (CDS)	X	X	X	X	X	X	X	X	X
SPX P/N MM-46225	Breakout Box	X	X	X	X	X	X	X	X	X
SPX P/N MM-46523	Terminal Test Probe Kit	X	X	X	X	X	X	X	X	X

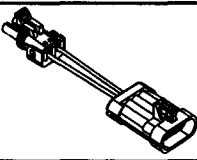
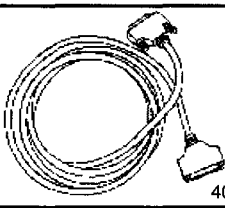
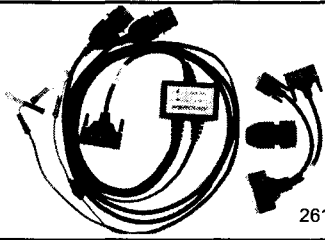
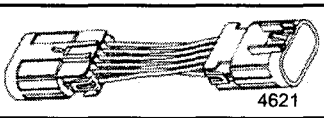
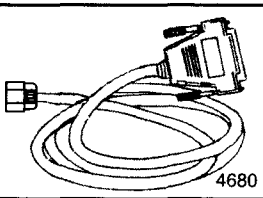
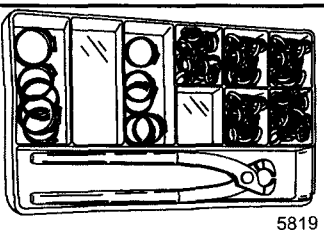
SmartCraft and Digital Throttle and Shift Tools

Data Cable Puller	888462A1
 <p>4618</p>	Attaches to end of DTS data harness to aid in pulling harness through boat. Prevents damage to DTS data harness.
2 to 4 Pin Harness Adapter	84-822560T12
 <p>4679</p>	Adapts the 2 pin Digital Diagnostic Terminal harness to the 4 pin connector on the engine.
Extension Cable	84-825003A1
 <p>4012</p>	Data link extension harness (3.05 m[10 ft.]) between the adapter harness and the Digital Diagnostic Terminal or Computer Diagnostic System (CDS).
Gauge Sweep Kit	84-889243A01
 <p>26132</p>	Connects the CDS to the 14-pin harness allowing the CDS to configure a helm without engines present. Also aids in testing the 14-pin harness.
Male to Male 10 Pin Adapter	84-892452A01
 <p>4621</p>	Allows connection between CAN 1 communications cable and Computer Diagnostic System in applications where a junction box is not used.
CAN 1 Diagnostic Cable	84-892663
 <p>4680</p>	Connects into a junction box or male to male adapter cable for Command Module configuration. Not for use with DDT.
Hose Clamp Tool Kit	91-803146A04
 <p>5819</p>	Aids in the installation of high pressure (Oetiker®) hose clamps.

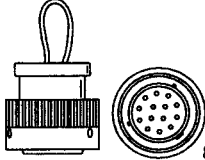
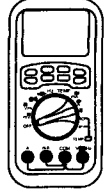
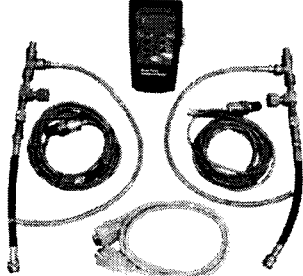
Section 5 - SmartCraft and Digital Throttle & Shift

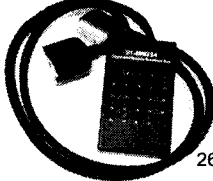
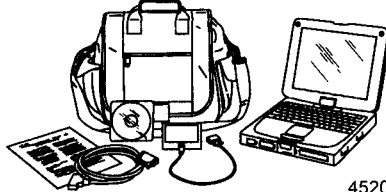
12 Volt Connector Tool	91-889675A01
 <p>8036</p>	Connects to data harness allowing operation of the DTS system with the Digital Diagnostic Terminal or CDS.
DMT 2004 Digital Multimeter	91-892647A01
 <p>4516</p>	Measures RPM on spark ignition (SI) engines, ohms, amperes, AC and DC voltages; records maximums and minimums simultaneously, and accurately reads in high RFI environments.
Digital Pressure Meter	91-892651A01
 <p>5786</p>	Connects to the fuel system/manifold and can be used in conjunction with Computer Diagnostic System (CDS).
De-pinning Tool	91-896352
 <p>17721</p>	Aids in the removal of wires from the 14 pin Deutsch connector.
Command Module MX Breakout Box	91-898254
 <p>26131</p>	Connects between the command module and the command module harness. Test harness circuits and the input/output voltage at the command module.
Computer Diagnostic System (CDS)	Order through SPX
 <p>4520</p>	<p>Monitors all electrical systems for proper function, diagnostics, and calibration purposes. For additional information, pricing, or to order the Computer Diagnostic System contact:</p> <p>SPX Corporation 28635 Mound Rd. Warren, MI 48092 or call: USA - 1-800-345-2233 Canada - 800-345-2233 Europe - 49 6182 959 149 Australia - (03) 9544-6222</p>

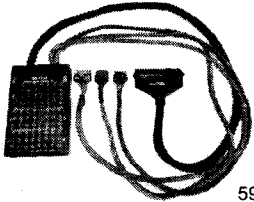
Breakout Box	SPX P/N MM-46225
 <p style="text-align: right;">5974</p>	Connects to Propulsion Control Module (PCM) to test engine circuits and components without probing wires. May be used with Computer Diagnostic System (CDS).

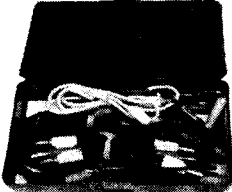
Terminal Test Probe Kit	SPX P/N MM-46523
 <p style="text-align: right;">7915</p>	Test probes adapt test meter leads to harness connections without damaging harness terminals. May be used with Computer Diagnostic System (CDS).





Computer Diagnostic System Adapter Cable Application Chart

Model	Serial Number	Processor	84-822560						84-892663	84-899150T01
			A1	A5	A6	A7	A10	A13		
V-175 EFI (2.5 L)	0T409000 - 0T800999	PCM555		X						
	0T801000 - 1B226999	PCM03		X						
	1B227000 & up	PCM03						X		
V-200 EFI (2.5 L)	0T409000 - 0T800999			X						
	0T801000 - 1B226999			X						
	1B227000 & up							X		
225 Carburetor (3.0 L)	0D280813 - 0G129221	Nippondenso	X							
	0G129222 - 0T800999	Nippondenso			X	X				
225/250 EFI (3.0 L)	0G129222 - 0T408999	Nippondenso			X	X				
3.0 L EFI SeaPro/ Marathon/200/225/250 EFI (3.0 L)	0T409000 - 0T800999	PCM555		X						
	0T801000 - 1B226999	PCM555		X						
	1B227000 & up	PCM555						X		
250XB EFI (3.0 L)	0G980600 - 0T800999				X					
75/90/115 DFI (1.5 L)	0T801000 - 1B226999	PCM03		X						
75/90/115 (1.5 L)	1B227000 & up							X		
V-135/150/175 DFI (2.5 L)	0G590000 - 0T178499	Non-555 OptiMax		X						
	0T178500 - 0T800999	PCM555		X						
	0T801000 - 1B226999	PCM03		X						
	1B227000 & up	PCM03						X		
200/225 DFI (3.0 L)	0G590000 - 0T178499	Non-555 OptiMax		X						
	0T178500 - 0T800999	PCM555		X						
	0T801000 - 1B226999	PCM03		X						
	0T801000 & up	PCM03						X		
200/225 DFI (3.0 L) - DTS	0T59900 - 0T800999	PCM555DTS		X						
	0T801000 - 1B226999	PCM03						X		
	0T801000 & up	PCM03						X		



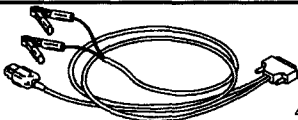

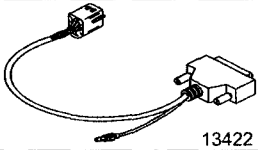
Section 5 - SmartCraft and Digital Throttle & Shift

Model	Serial Number	Processor	84-822560						84-892663	84-899150T01
			A1	A5	A6	A7	A10	A13		
25 (4-Stroke)	All applicable	Motorola				X	X			
25/30 EFI (4-Stroke) (MY 2006)	0R106999	Kokusan				X				X
30 EFI (4-Stroke)	0T409000 - 1B226999	PCM555		X						
30/40 (3 Cyl.) (4-Stroke)	All applicable	Motorola				X	X			
40 EFI (3 Cyl.) (4-Stroke)	All applicable	PCM555		X						
40/50/60 (4 Cyl.) (4-Stroke)	All applicable	Motorola				X	X			
40/50/60 EFI (4 Cyl.) (4-Stroke)	All applicable	PCM555		X						
75/90/115 EFI (4-Stroke)	All applicable	Mitsubishi						X		
75/90/115 EFI (1.7 L) (4-Stroke)	1B227000 & up	ECM07	X ¹					X		
135-175 Verado	1B227000 & up	PCM03/07	X ¹							
200-275 Verado	0T980000 & up	PCM03/07	X ¹							
225 EFI (4-Stroke)	0T653945 & up	Mitsubishi						X		
200/240/250 Jet	All applicable	PCM555		X						
DTS Command Module									X	

Computer Diagnostic System Adapter Cables

<p>Adapter Harness</p>  <p>4009</p>	<p>84-822560A5</p> <p>Data link harness between engine and Computer Diagnostic System (CDS) or Digital Diagnostic Terminal (DDT).</p>
<p>Adapter harness</p>  <p>25728</p>	<p>84-822560A6</p> <p>Data link harness between the engine and the Computer Diagnostic System (CDS). Use with 84-822560A7 or 84-822560A3.</p>
<p>Adapter Harness</p>  <p>13422</p>	<p>84-822560A7</p> <p>Data link harness between the engine ECM and the Computer Diagnostic System (CDS).</p>
<p>Adapter harness</p>  <p>25725</p>	<p>84-822560A10</p> <p>Data link harness between the engine and the Computer Diagnostic System (CDS). Use with 84-822560A7 only.</p>

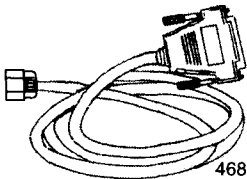
1. When use with 2 to 4 Pin Adapter Harness (84-822560A12)

<p>Adapter Harness</p>	<p>84-822560A13</p>
 <p>5826</p>	<p>Data link harness between engine and Computer Diagnostic System (CDS).</p>
<p>Adapter harness</p>	<p>84-822560A14</p>
 <p>25724</p>	<p>Data link harness between the engine and the Computer Diagnostic System (CDS).</p>
<p>CAN 1 Diagnostic Cable</p>	<p>84-892663</p>
 <p>4680</p>	<p>Connects into a junction box or male to male adapter cable for Command Module configuration. Not for use with DDT.</p>
<p>Adapter Harness</p>	<p>84-899150T01</p>
 <p>22175</p>	<p>Data link harness between the engine ECM and the Computer Diagnostic System (CDS).</p>

Notes:

Section 6 - Sport Jet Pump Models

Table of Contents



Sport Jet Pump Tool Application Chart.....	126	Sport Jet Pump Tools.....	127
--	-----	---------------------------	-----



Sport Jet Pump Tool Application Chart



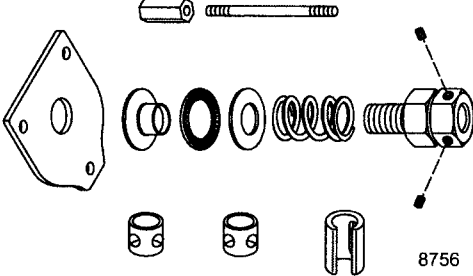

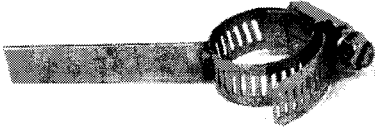
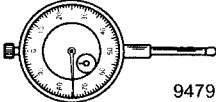
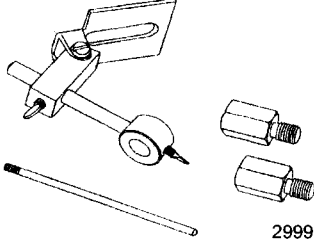
Part Number	Description	90/120	95XR/120XR	120XR ² /175XR ² /210M ² 240M ² /200 OptiMax	250 OptiMax
22-820573	Flushing Adapter	X	X		
91-14311A04	Bearing Preload Tool	X	X	X	X
91-34569A1	Slide Hammer	X	X	X	X
91-53459	Backlash Indicator Rod	X	X	X	X
91-58222A1	Dial Indicator	X	X	X	X
91-83155	Dial Indicator Adapter	X	X	X	X
91-83165T	Bearing Puller Assembly	X	X	X	X
91-820552 1	Bearing Installer	X	X		
91-820554	Seal Installer	X	X		
91-820555	Seal Installer	X	X		
91-820556	Bearing Cup Installer	X	X		
91-820557	Bearing Installer	X	X		
91-820558	Bushing Installer	X	X		
91-820559	Seal Installer	X	X		
91-820657	Impeller Shaft Wrench	X	X		
91-824827A1	Pinion Shaft Pre-load Kit	X	X		
91-824869A1	Thread Extending Kit	X	X	X	X
91-824870	Puller Bar	X	X	X	X
91-824871A1	Impeller Shaft Pre-load Kit	X	X		
91-824871A2	Impeller Shaft Pre-load Kit			X	X
91-824872T1	Impeller Nut Wrench	X	X		
91-824886	Bushing Installer	X	X		
91-824890T	Pinion Gear Height Location Tool	X			
91-824892	Driver Handle	X	X	X	X
91-827983T	Bearing Installer	X	X		
91-830103	Impeller Shaft Seal Protector		X		
91-831897	Pinion Gear Height Location Tool		X	X	
91-832016T	Bearing Installer		X	X	
91-832017	Bearing Installer		X	X	X
91-832018	Bearing Cup Installer		X	X	X
91-832019T	Seal Installer		X	X	
91-832093A1	Impeller Shaft Wrench		X	X	X
91-850233	Seal Protector		X	X	X
91-850297	Impeller Nut Socket		X	X	X
91-850831	Bushing Installer		X	X	X
91-882758	Pinion Gear Height Location Tool				X

Sport Jet Pump Tools

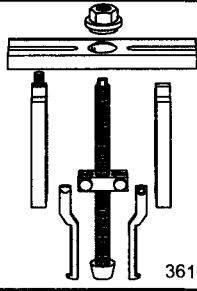
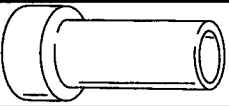
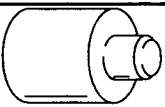
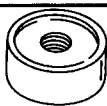
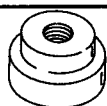
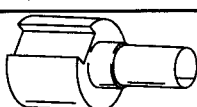
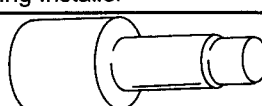
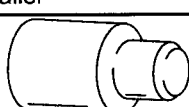
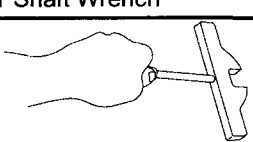

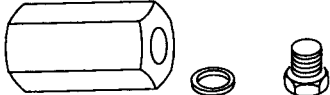
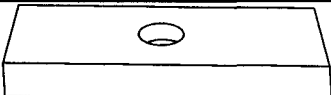
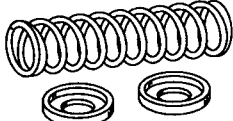
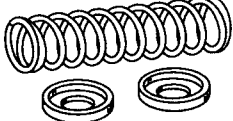
Flushing Adapter	22-820573
 <p>25438</p>	Adapts the water inlet hose fitting when flushing the cooling system.
Bearing Preload Tool	91-14311A04
 <p>8756</p>	Simulates a load on the driveshaft for accurate pinion height and backlash measurements.
Slide Hammer	91-34569A 1
 <p>6761</p>	Aids in the removal of various engine components. Use with puller jaws.
Backlash Indicator Rod	91-53459
 <p>10452</p>	Aids in checking gear backlash.
Dial Indicator	91-58222A1
 <p>9479</p>	Used to obtain a variety of measurements including gear backlash, pinion gear location, and TDC.
Dial Indicator Adapter	91-83155
 <p>2999</p>	Dial indicator holding fixture.

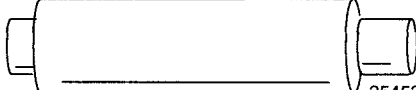
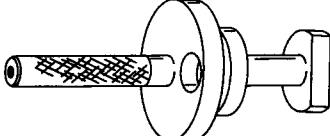
Section 6 - Sport Jet Pump Models

<p>Bearing Puller Assembly</p>	<p>91-83165T</p>
 <p>3610</p>	<p>Removes bearings, races and bearing carriers</p>
<p>Bearing Installer</p>	<p>91-820552 1</p>
 <p>25445</p>	<p>Installs a ball bearing onto a large outside diameter shaft.</p>
<p>Seal Installer</p>	<p>91-820554</p>
 <p>25448</p>	<p>Installs the stator seals.</p>
<p>Seal Installer</p>	<p>91-820555</p>
 <p>25451</p>	<p>Installs the ring guide onto the drive housing cover.</p>
<p>Bearing Cup Installer</p>	<p>91-820556</p>
 <p>25450</p>	<p>Installs the bearing cup into the pinion shaft housing and drive housing cover.</p>
<p>Bearing Installer</p>	<p>91-820557</p>
 <p>25446</p>	<p>Installs a ball bearing into the drive housing.</p>
<p>Bushing Installer</p>	<p>91-820558</p>
 <p>25447</p>	<p>Installs the stator bushing.</p>
<p>Seal Installer</p>	<p>91-820559</p>
 <p>25449</p>	<p>Installs the impeller shaft seals into the drive housing.</p>
<p>Impeller Shaft Wrench</p>	<p>91-820657</p>
 <p>25462</p>	<p>Secures the impeller shaft when removing or installing the impeller nut.</p>

Pinion Shaft Pre-load Kit	91-824827A1
 <p>25416</p>	Adapter that installs over the pinion shaft when checking the pinion gear height.
Thread Extending Kit	91-824869A1
 <p>25439</p>	Extends the reach for the dial indicator kit when checking gear lash.
Puller Bar	91-824870
 <p>25454</p>	Aids in pulling the drive housing seals out.
Impeller Shaft Pre-load Kit	91-824871A1
 <p>25417</p>	Applies a pre-load to the impeller shaft when checking gear lash.
Impeller Shaft Pre-load Kit	91-824871A2
 <p>25417</p>	Applies a pre-load to the impeller shaft when checking gear lash.
Impeller Nut Wrench	91-824872T1
 <p>25436</p>	Aids in the removal, installation, and torquing of the impeller nut.
Bushing Installer	91-824886
 <p>25452</p>	Installs the reverse gate bushings.
Pinion Gear Height Location Tool	91-824890T
 <p>25440</p>	Aids in determining the exact pinion gear height location.
Driver Handle	91-824892
 <p>25455</p>	Threaded driver handle used to assist in the installation of seals, bearings and cups.

Section 6 - Sport Jet Pump Models

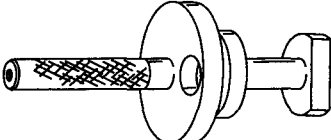
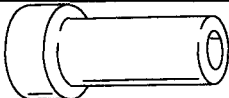
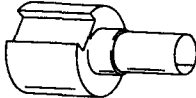
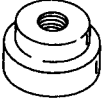
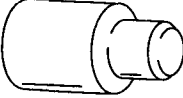
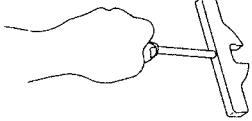
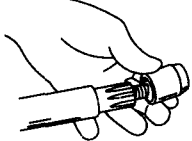
<p>Bearing Installer</p>  <p>25453</p>	<p>91-827983T</p> <p>Installs the taper roller bearing onto the pinion shaft.</p>
<p>Impeller Shaft Seal Protector</p>  <p>25437</p>	<p>91-830103</p> <p>Protects the impeller shaft seal during installation.</p>
<p>Pinion Gear Height Location Tool</p>  <p>25440</p>	<p>91-831897</p> <p>Aids in determining the exact pinion gear height location.</p>
<p>Bearing Installer</p>  <p>25442</p>	<p>91-832016T</p> <p>Installs the bearings and seals into the pinion shaft housing.</p>
<p>Bearing Installer</p>  <p>25446</p>	<p>91-832017</p> <p>Installs a ball bearing into the drive housing.</p>
<p>Bearing Cup Installer</p>  <p>25450</p>	<p>91-832018</p> <p>Installs the bearing cup into the pinion shaft housing and drive housing cover.</p>
<p>Seal Installer</p>  <p>25449</p>	<p>91-832019T</p> <p>Installs the pinion shaft seals into the drive housing.</p>
<p>Impeller Shaft Wrench</p>  <p>25462</p>	<p>91-832093A1</p> <p>Secures the impeller shaft when removing or installing the impeller nut.</p>
<p>Seal Protector</p>  <p>25456</p>	<p>91-850233</p> <p>Protects the impeller shaft seal during installation.</p>

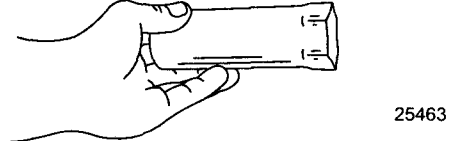
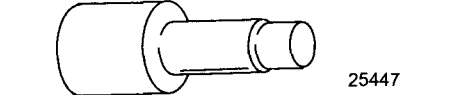
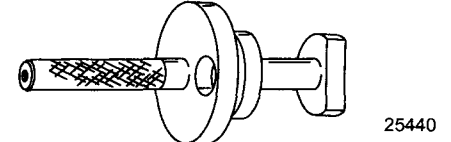
<p>Impeller Nut Socket</p>	<p>91-850297</p>
 <p>25463</p>	<p>Aids in the removal, installation, and torquing of the impeller nut.</p>
<p>Bushing Installer</p>	<p>91-850831</p>
 <p>25447</p>	<p>Installs the stator bushings and seals.</p>
<p>Pinion Gear Height Location Tool</p>	<p>91-882758</p>
 <p>25440</p>	<p>Aids in determining the exact pinion gear height location.</p>

